



宁波莱科液压器材有限公司
NINGBO LAIKE HYDRAULICS CO.,LTD

宁波莱科液压器材有限公司

NINGBO LAIKE HYDRAULICS CO.,LTD

地址: 宁波市鄞州区横溪工业区岐山路298号

ADD: NO.298,QISHAN ROAD,HENGXI INDUSTRIAL ZONE,YINZHOU DISTRICT,NINGBO,CHINA.

邮编P.C.: 315131

电话(Tel): +86-574-88472489 88471115

传真(Fax): +86-574-88471696





E-mail: laike@nblaike.cn

Http: www.nblaike.cn



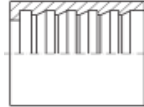
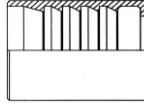
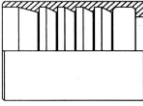

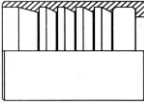
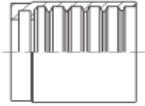
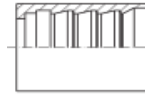
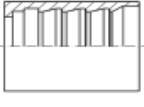

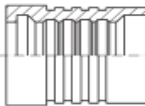
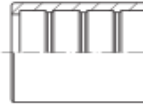
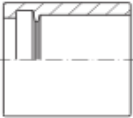



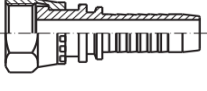

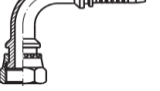

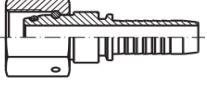

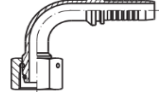

本样本部分产品为客户定制品，仅作参考。

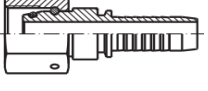
Parts of products are customized, only for reference

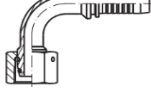
FERRULES 套筒

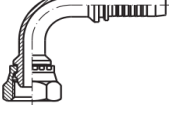
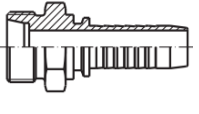
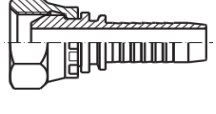
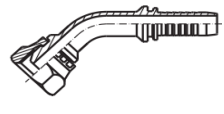
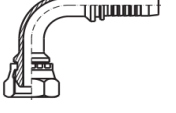
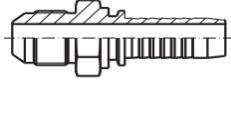
<p>FERRULE FOR ONE WIRE HOSE 配一层胶管套筒</p>	<p>00110A Non-skive</p>  <p>A1</p>	<p>00110 Non-skive</p>  <p>A1</p>	<p>01100 Skive</p>  <p>A1</p>	<p>FERRULE FOR TWO WIRE HOSE 配两层胶管套筒</p>
<p>00200 Skive</p>  <p>A2</p>	<p>00210 Non-skive</p>  <p>A2</p>	<p>01200 Skive</p>  <p>A2</p>	<p>FERRULE FOR ONE OR TWO WIRE HOSE 配一层或两层胶管套筒</p>	<p>03310 Non-skive</p>  <p>A3</p>
<p>FERRULE FOR FOUR WIRE HOSE 配四层胶管套筒</p>	<p>00400 Skive</p>  <p>A3</p>	<p>00401 Skive</p>  <p>A3</p>	<p>00402 Skive</p>  <p>A4</p>	<p>01400 Skive</p>  <p>A4</p>
<p>FERRULE FOR FOUR OR SIX WIRE HOSE, INTERLOCK 配四层或六层胶管套筒</p>	<p>00621 Skive</p>  <p>A4</p>	<p>FERRULE FOR NYLON HOSE 配尼龙树脂管套筒</p>	<p>00018</p>  <p>A5</p>	<p>FERRULE FOR TEFLON HOSE 配铁氟龙管套筒</p>
<p>00TF0</p>  <p>XYZ5</p>				

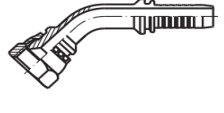
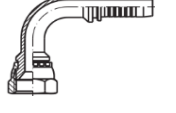
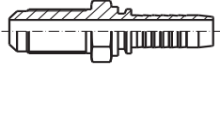



















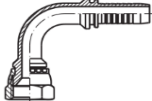
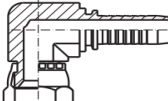

TWO PIECE FITTING 分体式扣压软管接头

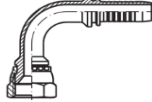
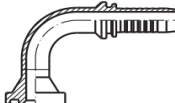
METRIC FLAT SEAL 公制螺纹平面密封	10311 M Metric - STR  B1	20211 F Metric - STR  B1	20241 F Metric - 45 Elbow  B2	20291 F Metric - 90 Elbow  B2
METRIC 24° CONE O-RING SEAL L.T. 公制螺纹24°锥密封轻系列	10411 M Metric - STR  B3	20411 F Metric - STR  B3	20441 F Metric - 45 Elbow  B4	20491 F Metric - 90 Elbow  B4
20411C F Metric - STR  B5	20441C F Metric - 45 Elbow  B5	20491C F Metric - 90 Elbow  B5	24° CONE O-RING SEAL S.T. 公制螺纹24°锥密封重系列	10511 M Metric - STR  B6
20511 F Metric - STR  B6	20541 F Metric - 45 Elbow  B7	20591 F Metric - 90 Elbow  B7	20511C F Metric - STR  B8	20541C F Metric - 45 Elbow  B8
20591C F Metric - 90 Elbow  B8	METRIC 60° CONE SEAL 公制螺纹60°锥密封	10611 M Metric - STR  B9	20611 F Metric - STR  B9	20641 F Metric - 45 Elbow  B10
20691 F Metric - 90 Elbow  B10	METRIC 74° CONE SEAL 公制螺纹74°锥密封	10711 M Metric - STR  B11	20711 F Metric - STR  B11	20741 F Metric - 45 Elbow  B12
20791 F Metric - 90 Elbow  B12	METRIC 90° CONE SEAL 公制螺纹90°锥密封	10811L M Metric - STR  B12	METRIC MULTISEAL 公制螺纹球面密封	20111 F Metric - STR  B13

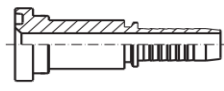

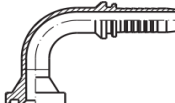
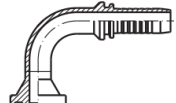
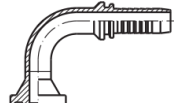
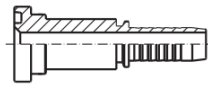
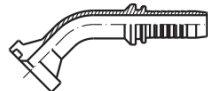
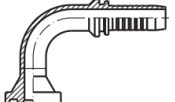
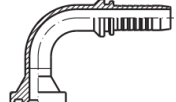
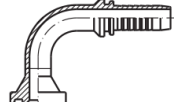
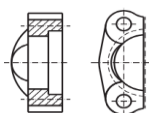
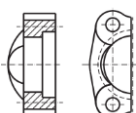







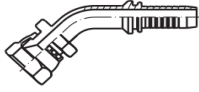
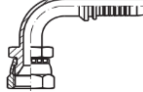

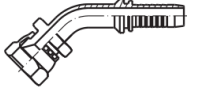
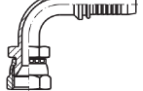
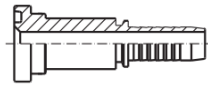
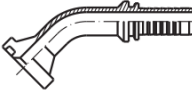
TWO PIECE FITTING 分体式扣压软管接头

<p>20141 F Metric - 45 Elbow</p>  <p style="text-align: right;">B13</p>	<p>20191 F Metric - 90 Elbow</p>  <p style="text-align: right;">B14</p>	<p style="text-align: center;">STANDPIPE 公制卡套直管</p>	<p>50011 Standpipe - STR</p>  <p style="text-align: right;">B15</p>	<p>50041 Standpipe - 45</p>  <p style="text-align: right;">B16</p>
<p>50091 Standpipe - 90</p>  <p style="text-align: right;">B17</p>	<p>NL/NS Metric Nut</p>  <p style="text-align: right;">B18</p>	<p>RL/RS Cutting Ring</p>  <p style="text-align: right;">B18</p>	<p style="text-align: center;">BSP O-RING SEAL 英制管螺纹 O形圈密封</p>	<p>12211 M BSP - STR</p>  <p style="text-align: right;">B19</p>
<p style="text-align: center;">BSP 60° CONE SEAL 英制管螺纹 60°锥密封</p>	<p>12611 M BSP - STR</p>  <p style="text-align: right;">B19</p>	<p>12611A M BSP - STR</p>  <p style="text-align: right;">B20</p>	<p>22611 F BSP - STR</p>  <p style="text-align: right;">B20</p>	<p>22611D F BSP - Double H.</p>  <p style="text-align: right;">B21</p>
<p>22611D-SM F BSP - Small D.H.</p>  <p style="text-align: right;">B21</p>	<p>22641 F BSP - 45 Elbow</p>  <p style="text-align: right;">B21</p>	<p>22691 F BSP - 90 Elbow</p>  <p style="text-align: right;">B22</p>	<p>22691K F BSP - 90 Compact</p>  <p style="text-align: right;">B22</p>	<p style="text-align: center;">BSP MULTI SEAL 英管螺纹 球面密封</p>
<p>22111 F BSP - STR</p>  <p style="text-align: right;">B23</p>	<p>22141 F BSP - 45 Elbow</p>  <p style="text-align: right;">B23</p>	<p>22191 F BSP - 90 Elbow</p>  <p style="text-align: right;">B24</p>	<p style="text-align: center;">BSP FLAT SEAL 英管螺纹 平面密封</p>	<p>22211 F BSP - STR</p>  <p style="text-align: right;">B25</p>
<p>22241 F BSP - 45 Elbow</p>  <p style="text-align: right;">B25</p>	<p>22291 F BSP - 90 Elbow</p>  <p style="text-align: right;">B25</p>	<p style="text-align: center;">BSPT 英制锥管螺纹</p>	<p>13011-SP M BSPT - STR</p>  <p style="text-align: right;">B24</p>	<p style="text-align: center;">ORFS FACE SEAL 美制ORFS螺纹 平面密封</p>
<p>14211 M ORFS- STR</p>  <p style="text-align: right;">B26</p>	<p>24211 F ORFS - STR</p>  <p style="text-align: right;">B26</p>	<p>24241 F ORFS - 45 Elbow</p>  <p style="text-align: right;">B27</p>	<p>24291 F ORFS - 90 Elbow</p>  <p style="text-align: right;">B27</p>	<p style="text-align: center;">NPTF 美制锥螺纹</p>

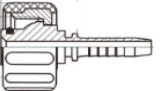

TWO PIECE FITTING 分体式扣压软管接头

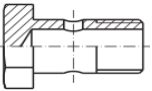
<p>15611 M NPT - STR</p>  <p>B28</p>	<p>15611SW M NPT - SWIVEL</p>  <p>B28</p>	<p>SAE O-RING SEAL 美制SAE螺纹 O型圈密封</p>  <p>B30</p>	<p>16011 M SAE - STR</p>  <p>B29</p>	<p>JIC 74° CONE SEAL 美制JIC螺纹 74°锥密封</p>  <p>B31</p>
<p>16711 M JIC - STR</p>  <p>B29</p>	<p>16711L M JIC - Long</p>  <p>B30</p>	<p>26711 F JIC - STR</p>  <p>B30</p>	<p>26711D F JIC - Double H.</p>  <p>B31</p>	<p>26711D-SM F JIC - Small D.H.</p>  <p>B31</p>
<p>26741 F JIC - 45 Elbow</p>  <p>B32</p>	<p>26791 F JIC - 90 Elbow</p>  <p>B32</p>	<p>26791K F JIC - 90 Compact</p>  <p>B33</p>	<p>SAE 90° CONE SEAL 美制SAE螺纹 90°锥密封</p>  <p>B34</p>	<p>17811 M SAE - STR</p>  <p>B34</p>
<p>27811 F SAE - STR</p>  <p>B34</p>	<p>27841 F SAE - 45 Elbow</p>  <p>B34</p>	<p>27891 F SAE - 90 Elbow</p>  <p>B35</p>	<p>NPSM 60° CONE SEAL 美制NPSM螺纹 60°锥面密封</p>  <p>B36</p>	<p>21611 F NPSM - STR</p>  <p>B35</p>
<p>SAE CODE 61 FLANGE SAE法兰轻系列</p>  <p>B36</p>	<p>87311 Code 61 Flange</p>  <p>B36</p>	<p>87341 Code 61 Flange</p>  <p>B36</p>	<p>87391 Code 61 Flange</p>  <p>B37</p>	<p>87391-H Long Drop</p>  <p>B37</p>
<p>SAE CODE 63 FLANGE SAE法兰重系列</p>  <p>B37</p>	<p>87611 Code 62 Flange</p>  <p>B38</p>	<p>87641 Code 62 Flange</p>  <p>B38</p>	<p>87691 Code 62 Flange</p>  <p>B38</p>	<p>87691-H Long Drop</p>  <p>B38</p>
<p>SAE SPLIT FLANGE SAE法兰夹</p>  <p>B39</p>	<p>FL Split Flange - L.T</p>  <p>B39</p>	<p>FS Split Flange - H.T</p>  <p>B39</p>	<p>JIS METRIC 60° CONE SEAL SEAL 日式公制螺纹 60°锥密封</p>  <p>B39</p>	<p>18611 M JIS M - STR</p>  <p>B39</p>

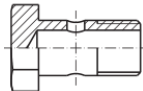
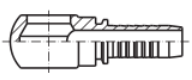
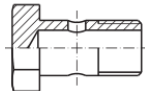





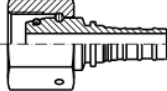
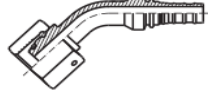
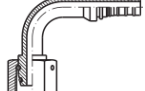

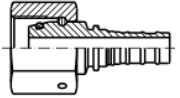
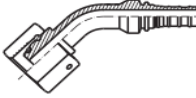
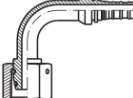

TWO PIECE FITTING 分体式扣压软管接头

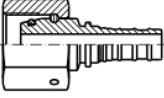
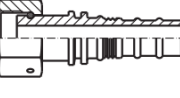
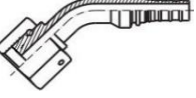
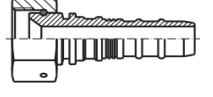
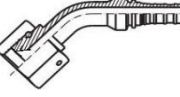
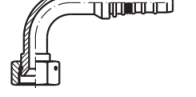
<p>28611 F JIS Metric</p>  <p>B40</p>	<p>28641 F JIS Metric</p>  <p>B40</p>	<p>28691 F JIS Metric</p>  <p>B40</p>	<p>JIS GAS 60° CONE SEAL 日本英制螺纹 60°锥密封</p>  <p>B41</p>	
<p>29611 F JIS GAS - STR</p>  <p>B41</p>	<p>29641 F JIS GAS</p>  <p>B41</p>	<p>29691 F JIS GAS</p>  <p>B42</p>	<p>JIS FLANGE 日制法兰</p>  <p>B42</p>	
<p>88141 JIS Flange - STR</p>  <p>B42</p>	<p>88191 JIS Flange - STR</p>  <p>B42</p>	<p>MT STAPLELOCK 煤炭部标准 矿用接头</p>  <p>B43</p>	<p>METRIC WATERWASH INSERTS 公制螺纹水管接头</p>  <p>B43</p>	
<p>20011 Water Insert</p>  <p>B43</p>	<p>DOUBLE CONNECTOR 双面连接接头</p>  <p>B43</p>	<p>90011/90012 Double Connector</p>  <p>B43</p>	<p>BANJO FITTING 铰接接头</p>  <p>B44</p>	
<p>700M Metric Bolt</p>  <p>B44</p>	<p>71011 Metric Banjo</p>  <p>B45</p>	<p>710M Metric Bolt</p>  <p>B45</p>	<p>72011 BSP Banjo</p>  <p>B46</p>	<p>720B BSP Bolt</p>  <p>B46</p>



TWO PIECE INTERLOCK FITTING 分体式剥内外胶软管接头

<p>24° CONE O-RING SEAL H.T. 公制螺纹24° 锥密封重系列</p>  <p>B47</p>	<p>10513 M Metric - STR</p>  <p>B47</p>	<p>20513 F Metric - STR</p>  <p>B47</p>	<p>20543 F Metric - 45 Elbow</p>  <p>B47</p>	<p>20593 F Metric - 90 Elbow</p>  <p>B47</p>
--	--	--	--	---

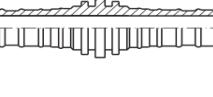
TWO PIECE INTERLOCK FITTING 分体式剥内外胶软管接头

<p>BSP 英制螺纹</p>	<p>12613 M BSP - STR</p>  <p style="text-align: right;">B48</p>	<p>22613-W F BSP - STR</p>  <p style="text-align: right;">B48</p>	<p>22643-W F BSP - 45 Elbow</p>  <p style="text-align: right;">B48</p>	<p>22693-W F BSP - 90 Elbow</p>  <p style="text-align: right;">B48</p>
<p>BSPT 英锥管螺纹</p>	<p>13013-SP M BSPT - STR</p>  <p style="text-align: right;">B49</p>	<p>NPTF 美制锥管螺纹</p>	<p>15613 M NPT - STR</p>  <p style="text-align: right;">B49</p>	<p>NPSM 60° CONE SEAL 美制NPSM 60°锥密封</p>
<p>21613-W F NPSM - STR</p>  <p style="text-align: right;">B49</p>	<p>ORFS FACE SEAL 美制ORFS 螺纹平面密封</p>	<p>24213-W F ORFS - STR</p>  <p style="text-align: right;">B50</p>	<p>24243-W F ORFS - 45 Elbow</p>  <p style="text-align: right;">B50</p>	<p>24293-W F ORFS - 90 Elbow</p>  <p style="text-align: right;">B50</p>
<p>JIC 74° CONE SEAL 美制JIC螺纹 74°密封</p>	<p>26713-W F JIC - STR</p>  <p style="text-align: right;">B51</p>	<p>26743-W F JIC - 45 Elbow</p>  <p style="text-align: right;">B51</p>	<p>26793-W F JIC - 90 Elbow</p>  <p style="text-align: right;">B51</p>	<p>26713D-W F JIC - DOUBLE H.</p>  <p style="text-align: right;">B51</p>
<p>JIS GAS 60° CONE SEAL 日本英制螺纹 60°密封</p>	<p>29613-W F JIS GAS - STR</p>  <p style="text-align: right;">B52</p>	<p>SAE Flange H.T SAE 法兰</p>	<p>87613 Code 62 Flange</p>  <p style="text-align: right;">B52</p>	<p>87643 Code 62 Flange</p>  <p style="text-align: right;">B52</p>
<p>87693 Code 62 Flange</p>  <p style="text-align: right;">B52</p>	<p>Caterpillar Flange 9000PSI 法兰</p>	<p>87913 Caterpillar Flange</p>  <p style="text-align: right;">B53</p>	<p>87943 Caterpillar Flange</p>  <p style="text-align: right;">B53</p>	<p>87993 Caterpillar Flange</p>  <p style="text-align: right;">B53</p>
<p>DOUBLE CONNECTOR 双面连接接头</p>	<p>90013 Double Connector</p>  <p style="text-align: right;">B53</p>			

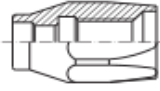
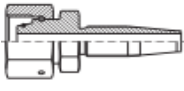
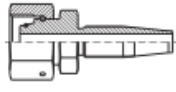
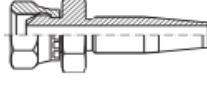
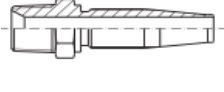
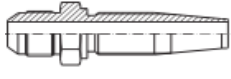
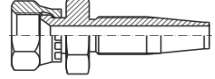
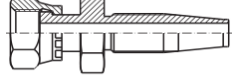
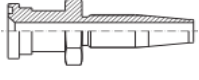
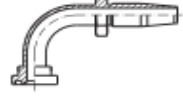
REUSABLE FITTING 可拆式软管接头

<p>REUSABLE FERRULE 可拆式套筒</p>	<p>00518 Reusable Ferrule</p>  <p>B54</p>	<p>24° CONE O-RING SEAL L.T. 公制螺纹24° 锥密封轻系列</p>	<p>20418D F Metric - L.T.</p>  <p>B54</p>	<p>24° CONE O-RING SEAL H.T. 公制螺纹24° 锥密封重系列</p>
<p>20518D F Metric - H.T.</p>  <p>B54</p>	<p>BSP 英制螺纹</p>	<p>22618D F BSP - STR</p>  <p>B55</p>	<p>NPTF 美制锥管螺纹</p>	<p>15618 M NPT - STR</p>  <p>B55</p>
<p>JIC 74° CONE SEAL 美制JIC螺纹 74°密封</p>	<p>16718 M JIC - STR</p>  <p>B55</p>	<p>26718D F JIC - STR</p>  <p>B56</p>	<p>ORFS FACE SEAL 美制ORFS 螺纹平面密封</p>	<p>24218D F ORFS - STR</p>  <p>B56</p>
<p>SAE Flange SAE 法兰</p>	<p>87318D Code 61 Flange</p>  <p>B57</p>	<p>87398D Code 61 Flange</p>  <p>B57</p>	<p>87698D Code 62 Flange</p>  <p>B57</p>	

Ferrule for SAE 100 R1AT/EN853 1SN Hose - Non Skive

SAE100R1AT/EN853 1SN软管套筒, 不剥胶

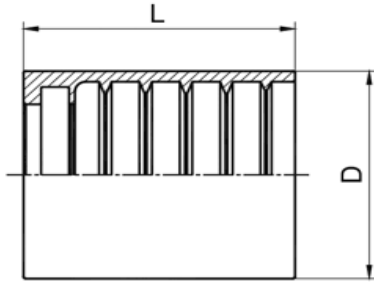

00110-A

PART NO 型号	HOSE 软管		DIMENSION 尺寸	
	DN	DASH	D	L
	00110-04A	6	4	21
00110-05A	8	5	21.8	31
00110-06A	10	6	24.3	32
00110-08A	13	8	28.4	34
00110-10A	16	10	32	37
00110-12A	19	12	35.5	43
00110-16A	25	16	44	50
00110-20A	32	20	53	59
00110-24A	38	24	59.3	74
00110-32A	51	32	73.5	77

Ferrule for SAE 100 R1AT/EN853 1SN Hose - Non Skive

SAE100R1AT/EN853 1SN软管套筒, 不剥胶

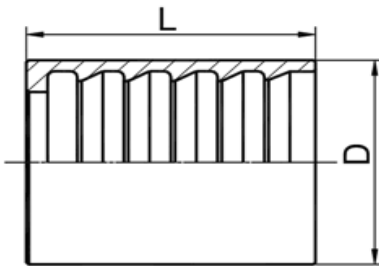

00110

PART NO 型号	HOSE 软管		DIMENSION 尺寸	
	DN	DASH	D	L
	00110-03	5	3	17.5
00110-04	6	4	20.6	30
00110-05	8	5	20.8	31
00110-06	10	6	23.3	32
00110-08	13	8	27	34
00110-10	16	10	30	37
00110-12	19	12	34	43
00110-16	25	16	42.6	50
00110-20	32	20	52	59
00110-24	38	24	58	74
00110-32	51	32	72	78

Ferrule for GB One Wire Hose - Skive
国产一层钢丝编织软管套筒, 剥胶

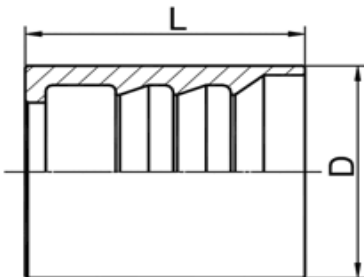

01100

PART NO 型号	HOSE 软管		DIMENSION 尺寸	
	DN	DASH	D	L
	01100-04	6	4	19
01100-05	8	5	21	32
01100-06	10	6	23	32
01100-08	13	8	28	34
01100-10	16	10	31	37
01100-12	19	12	34	43
01100-16	25	16	41	50
01100-20	32	20	49	59
01100-24	38	24	55	74

Ferrule for SAE 100 R2AT/EN853 2SN Hose - Skive

SAE100R2AT/EN853 2SN软管套筒, 剥胶

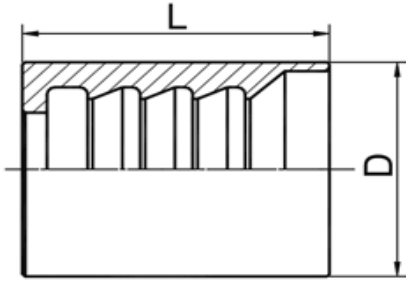

00200

PART NO 型号	HOSE 软管		DIMENSION 尺寸	
	DN	DASH	D	L
	00200-04	6	4	21
00200-05	8	5	22.5	31
00200-06	10	6	24	32
00200-08	13	8	28.7	34
00200-10	16	10	31.5	37
00200-12	19	12	36	43
00200-16	25	16	44	50
00200-20	32	20	54.5	59
00200-24	38	24	62	74
00200-32	51	32	75	78

Ferrule for SAE 100 R2AT/EN853 2SN Hose - Non Skive

SAE100R2AT/EN853 2SN软管套筒, 不剥胶

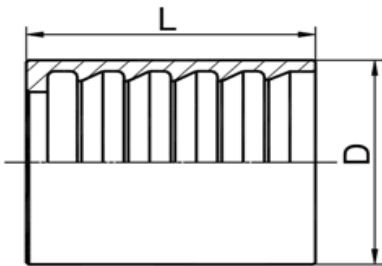

00210

PART NO 型号	HOSE 软管		DIMENSION 尺寸	
	DN	DASH	D	L
	00210-04	6	4	22.3
00210-05	8	5	23	31
00210-06	10	6	25	32
00210-08	13	8	28.7	34
00210-10	16	10	31.5	37
00210-12	19	12	35.5	43
00210-16	25	16	45	50
00210-20	32	20	55	59
00210-24	38	24	62.5	74
00210-32	51	32	75.5	78

Ferrule for GB Two Wire Hose - Skive
国产两层钢丝编织软管套筒, 剥胶

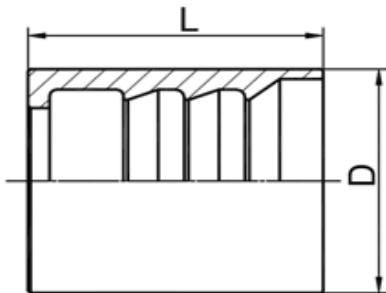

01200

PART NO 型号	HOSE 软管		DIMENSION 尺寸	
	DN	DASH	D	L
	01200-04	6	4	21
01200-05	8	5	23	31
01200-06	10	6	25	32
01200-08	13	8	31	34
01200-10	16	10	34	39
01200-12	19	12	37	43
01200-16	25	16	43	50
01200-20	32	20	51	59
01200-24	38	24	57	74
01200-32	51	32	70	78

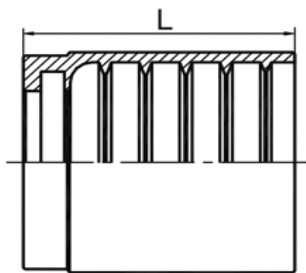
Ferrule for SAE 100R1AT\ R2AT, EN853
1SN\2SN - Non Skive
SAE 100R1AT\R2AT、EN853 1SN\2SN软管套筒, 不剥胶

03310

PART NO 型号	HOSE 软管		DIMENSION 尺寸	
	DN	DASH	D	L
	03310-04	6	4	23.2
03310-05	8	5	24	30
03310-06	10	6	26	32
03310-08	13	8	29.9	34
03310-10	16	10	33	36
03310-12	19	12	37.2	42
03310-16	25	16	46.2	50
03310-20	32	20	59	59
03310-24	38	24	67	72
03310-32	51	32	80	75

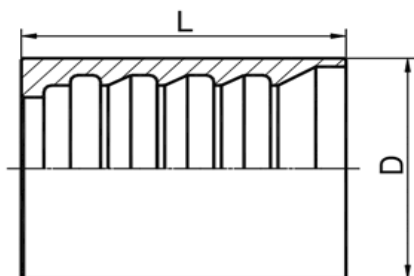
FERRULE FOR FOUR WIRE HOSE 配四层胶管套筒系列

SAE 100 R12/06-16, GB 10544 3型/20-32, DIN 20023-4SP, 4SH/10-16 Hose Ferrule - Skive 四层胶管套筒-剥胶

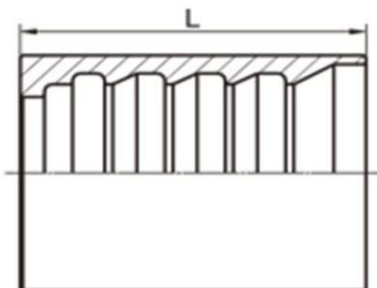
00400

PART NO 型号	HOSE 软管		DIMENSION 尺寸	
	DN	DASH	D	L
	00400-04	6	4	22
00400-06	10	6	25.5	39
00400-08	13	8	30	41
00400-10	16	10	33	43
00400-12	19	12	37	51
00400-16	25	16	46.5	61.5
00400-20	32	20	57	67.5
00400-24	38	24	65	75
00400-32	51	32	79	79

DIN 20023-4SH Hose Ferrule - Skive
DIN 20023-4SH 软管套筒, 剥胶

00401

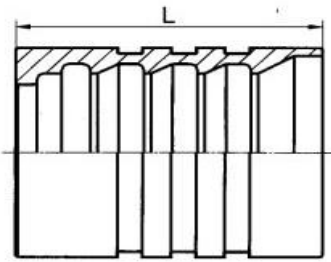
PART NO 型号	HOSE 软管		DIMENSION 尺寸	
	DN	DASH	D	L
	00401-16	25	16	49.5
00401-20	32	20	53	67.5
00401-24	38	24	61	75
00401-32	51	32	77	79

Ferrule for SAE 100R9AT-R12, EN856-4SP/04-16-Skive
 四层软管套筒, 剥胶



00402

PART NO 型号	HOSE 软管		DIMENSION 尺寸	
	DN	DASH	D	L
	00402-04	6	4	21.5
00402-06	10	6	26	33
00402-08	13	8	30	34
00402-10	16	10	33	39
00402-12	19	12	38	40
00402-16	25	16	46	51
00402-20	32	20	55	60
00402-24	38	24	63	70
00402-32	51	32	77	72

SAE 100 R12/20-24 , GB 10544 5Type Hose Ferrule - Skive
 SAE 100 R12/20-24 , GB 10544 5型软管套筒, 剥胶

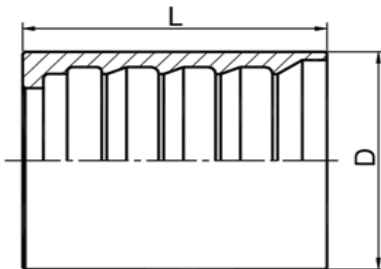

01400

PART NO 型号	HOSE 软管		DIMENSION 尺寸	
	DN	DASH	D	L
	01400-06	10	6	27.5
01400-08	13	8	31.5	41
01400-10	16	10	34	43
01400-12	19	12	39	51
01400-16	25	16	46.5	61.5
01400-20	32	20	55.5	67.5
01400-24	38	24	63.5	75
01400-32	51	32	78	79

FERRULE FOR SIX WIRE HOSE 配六层胶管套筒系列

Interlock Ferrule for SAE 100R13/R15、4SH/12-16 HOSE - Skive
 SAE 100 R13/R15、4SH/12-16 软管剥内外胶套筒

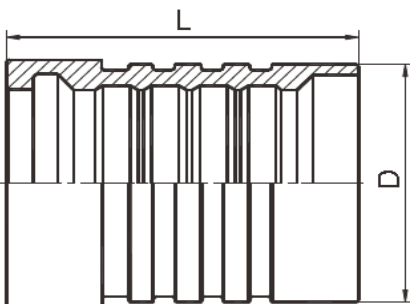

00621

PART NO 型号	HOSE 软管		DIMENSION 尺寸	
	DN	DASH	D	L
	00621-12	19	12	39.5
00621-16	25	15	48.5	66
00621-20	32	20	59	88
00621-24	38	24	69.3	102
00621-32	51	32	84.5	106

FERRULE FOR SAE100R7/R8 HOSE
SAE 100 R7/R8软管套筒

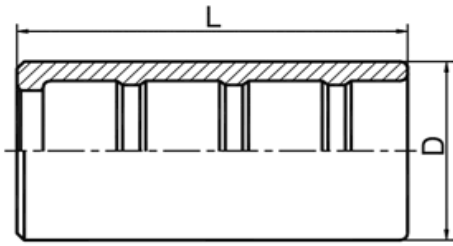

00018

PART NO 型号	HOSE 软管		DIMENSION 尺寸	
	DN	DASH	D	L
	00018-03	5	3	14.2
00018-04	6	4	17	29
00018-05	8	5	18.8	31
00018-06	10	6	21	31
00018-08	12	8	25.5	34
00018-10	16	10	31.5	36
00018-12	20	12	33	43

FERRULE FOR TEFLON HOSE 配铁氟龙管套筒系列

Ferrule for Teflon Hose
铁氟龙管套筒

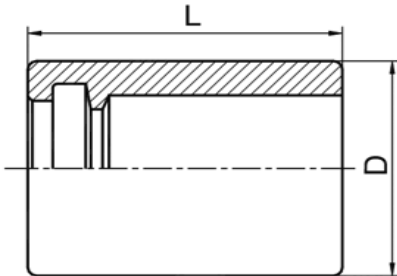

00TF0

PART NO 型号	HOSE 软管		DIMENSION 尺寸	
	DN	DASH	D	L
	00TF0-03	4	3	
00TF0-04	6	4	14.5	30.7
00TF0-05	8	5	16.5	30.6
00TF0-06	10	6	19	32.1
00TF0-08	12	8	24	34.3
00TF0-10	16	10	27	37
00TF0-12	20	12	30.1	42.8
00TF0-14	22	14	33.4	42.7
00TF0-16	25	16	38	50.8

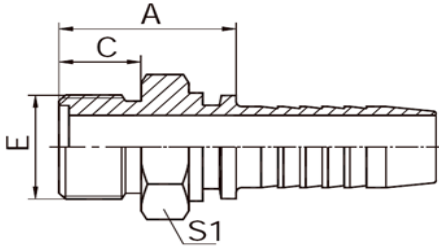
M Metric - O-Ring Flat Seal
 公制外螺纹平面o形圈密封

10311

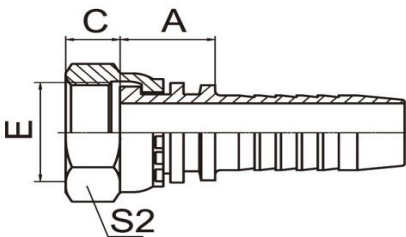
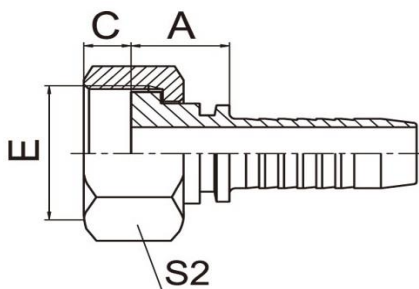
PART NO 型号	THREAD	HOSE		DIMENSION		
	螺纹	软管		尺寸		
	E	DN	DASH	A	C	S1
10311-12-04	M12X1.25	6	4	22.5	10	14
10311-14-04	M14X1.5	6	4	23.5	11	17
10311-16-04	M16X1.5	6	4	23.5	11	17
10311-16-05	M16X1.5	8	5	23.5	11	17
10311-16-06	M16X1.5	10	6	23.5	11	17
10311-18-06	M18X1.5	10	6	23.5	11	19
10311-22-05	M22X1.5	8	5	27	12	22
10311-22-06	M22X1.5	10	6	26	12	22
10311-22-08	M22X1.5	12	8	26.5	12	22
10311-27-10	M27X1.5	16	10	31.5	13	27
10311-30-12	M30X1.5	20	12	33.5	14	32
10311-36-12	M36X2	20	12	35.5	16	38
10311-36-14	M36X2	22	14	35.5	16	38
10311-39-16	M39X2	25	16	39	16	41
10311-45-20	M45X2	32	20	44.5	20	46
10311-52-24	M52X2	40	24	47.5	22	55
10311-64-32	M64X2	50	32	52.5	27	65

F Metric - Flat Seal
 公制内螺纹平面密封

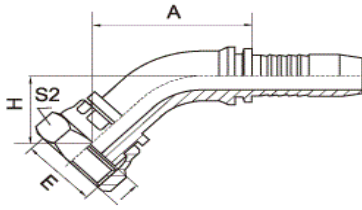
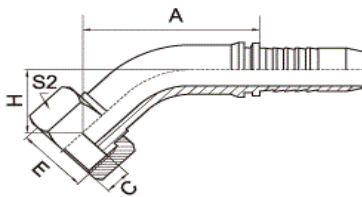
20211

20211-T

PART NO 型号	THREAD	HOSE		DIMENSION		
	螺纹	软管		尺寸		
	E	DN	DASH	A	C	S2
20211-14-04	M14X1.5	6	4	15.5	8.5	19
20211-14-05	M14X1.5	8	5	15.5	8.5	19
20211-16-04	M16X1.5	6	4	16.5	8	22
20211-16-05	M16X1.5	8	5	16.5	8	22
20211-16-06	M16X1.5	10	6	16.5	8	22
20211-18-06	M18X1.5	10	6	17.5	8	24
20211-20-08	M20X1.5	12	8	18.5	10	27
20211-22-08	M22X1.5	12	8	18.5	10	27
20211-22-10	M22X1.5	16	10	19.5	10	27
20211-24-10	M24X1.5	16	10	20.5	10.5	30
20211-30-12	M30X1.5	20	12	21.5	11	36
20211-33-14	M33X2	22	14	21.5	13	41
20211-42-20	M42X2	32	20	26	15	50
20211-18-05T	M18X1.5	8	5	17.5	8	24
20211-20-06T	M20X1.5	10	6	16	10	24
20211-22-06T	M22X1.5	10	6	16	10	27
20211-24-08T	M24X1.5	12	8	16.5	11	30
20211-27-08T	M27X1.5	12	8	18.5	10	32
20211-27-10T	M27X1.5	16	10	19.5	10	32
20211-36-12T	M36X2	20	12	20	13	41
20211-36-14T	M36X2	22	14	20	13	41
20211-39-16T	M39X2	25	16	23.5	13	46
20211-45-20T	M45X2	32	20	25	15	55
20211-52-24T	M52X2	40	24	25	17	60
20211-60-28T	M60X2	45	28	26	20	70
20211-64-32T	M64X2	50	32	26	23	75

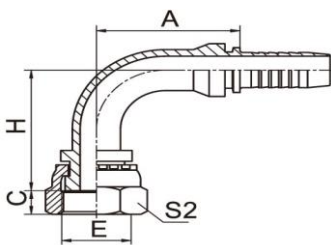
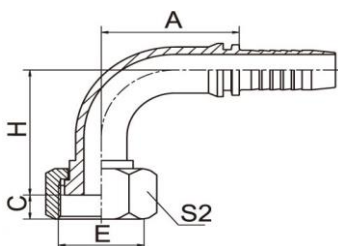
F Metric - Flat Seal - 45°
45°公制内螺纹平面

20241

20241-T

PART NO 型号	THREAD	HOSE		DIMENSION			
	螺纹	软管		尺寸			
	E	DN	DASH	A	C	H	S2
20241-14-04	M14X1.5	6	04	40.5	8.5	18.5	19
20241-14-05	M14X1.5	8	05	42.7	8.5	19.3	19
20241-16-05	M16X1.5	8	05	44.4	8.5	20	22
20241-18-06	M18X1.5	10	06	45.7	8	21.4	24
20241-22-08	M22X1.5	12	08	58.9	10	24	27
20241-30-12	M30X1.5	20	12	78.1	11	30	36
20241-36-16	M36X2	25	16	85.7	13	31.5	41
20241-42-20	M42X2	32	20	97.3	15	36.6	50
20241-27-10T	M27X1.5	16	10	68.6	10	24.3	32
20241-36-12T	M36X2	20	12	75	13	27.5	41
20241-36-14T	M36X2	22	14	77.3	13	27	41
20241-39-16T	M39X2	25	16	83.9	13	29.7	46
20241-45-20T	M45X2	32	20	94.5	15	33.8	55
20241-52-20T	M52X2	32	20	94.5	17	33.8	60
20241-52-24T	M52X2	40	24	108.5	17	37.7	60
20241-60-28T	M60X2	45	28	118.7	20	43.6	70
20241-64-32T	M64X2	50	32	127.8	23	45.6	75

F Metric - Flat Seal - 90°
90°公制内螺纹平面

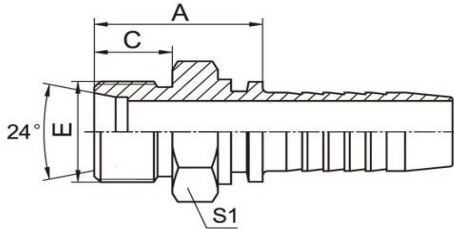
20291

20291-T

PART NO 型号	THREAD	HOSE		DIMENSION			
	螺纹	软管		尺寸			
	E	DN	DASH	A	C	H	S2
20291-12-02	M12X1.5	4	2	26.5	8	30.5	17
20291-12-04	M12X1.5	6	4	30	8	33.5	17
20291-14-04	M14X1.5	6	4	30	8.5	34	19
20291-14-05	M14X1.5	8	5	33	8.5	37	19
20291-16-04	M16X1.5	6	4	30	8	35	22
20291-16-05	M16X1.5	8	5	34	8	38	22
20291-16-06	M16X1.5	10	6	35.3	8	40.3	22
20291-18-06	M18X1.5	10	6	35.75	8	41.3	24
20291-22-08	M22X1.5	12	8	41	10	48	27
20291-22-10	M22X1.5	16	10	57.5	10	53	27
20291-30-12	M30X1.5	20	12	66.2	11	63.5	36
20291-33-14	M33X2	22	14	71.2	13	65	41
20291-36-16	M36X2	25	16	76.7	13	70	41
20291-42-20	M42X2	32	20	91.5	15	82.5	50
20291-18-05T	M18X1.5	8	5	33	8	39	24
20291-24-08T	M24X1.5	12	8	41	11	45.5	30
20291-27-04T	M27X1.5	6	4	30	10	35.5	32
20291-27-08T	M27X1.5	12	8	41	10	46	32
20291-27-10T	M27X1.5	16	10	56	10	51	32
20291-36-14T	M36X2	22	14	71.2	13	61	41
20291-39-16T	M39X2	25	16	76.7	13	67.5	46
20291-45-20T	M45X2	32	20	91.5	15	78.5	55
20291-52-20T	M52X2	32	20	91.5	17	78.5	60
20291-52-24T	M52X2	40	24	109.4	17	92	60
20291-60-28T	M60X2	45	28	119.9	20	106.5	70
20291-64-32T	M64X2	50	32	131	23	113.3	75

M Metric L - 24° Cone 公制外螺纹24°内锥面轻系列



10411

PART NO 型号	THREAD	HOSE	TUBE	DIMENSION		
	螺 纹	软管	硬管	尺 寸		
	E	DN	OD	A	C	S1
10411-12-04	M12X1.5	6	6	20.5	10	12
10411-14-04	M14X1.5	6	8	20.5	10	14
10411-14-05	M14X1.5	8	8	21.5	10	14
10411-16-04	M16X1.5	6	10	22.5	11	17
10411-16-05	M16X1.5	8	10	22.5	11	17
10411-16-06	M16X1.5	10	10	22.5	11	17
10411-18-05	M18X1.5	8	12	23.5	11	19
10411-18-06	M18X1.5	10	12	21.5	11	19
10411-22-06	M22X1.5	10	15	24.5	12	24
10411-22-08	M22X1.5	12	15	26	12	24
10411-26-08	M26X1.5	12	18	26.5	12	27
10411-26-10	M26X1.5	16	18	27	12	27
10411-27-10	M27X1.5	16	18	32	14	30
10411-30-10	M30X2	16	22	29	14	32
10411-30-12	M30X2	20	22	29	14	32
10411-36-16	M36X2	25	28	31.5	14	38
10411-45-20	M45X2	32	35	36	16	46
10411-52-24	M52X2	40	42	38	16	55

F Metric L - 24° Cone with O-Ring 公制内螺纹24°内锥面轻系列

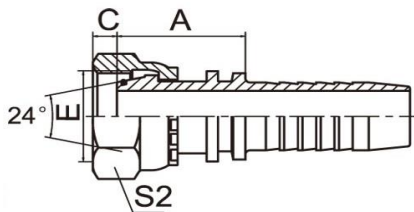

20411

PART NO 型号	THREAD	HOSE	TUBE	O-RING	DIMENSION		
	螺 纹	软管	硬管	O型圈	尺 寸		
	E	DN	OD	E	A	C	S2
20411-12-04	M12X1.5	6	6	O04.5X1.5	26	1	17
20411-14-04	M14X1.5	6	8	O06.5X1.5	28	2	19
20411-14-06	M14X1.5	10	8	O06.5X1.5	28	2	19
20411-16-04	M16X1.5	6	10	O08.0X1.5	28	2	22
20411-16-05	M16X1.5	8	10	O08.0X1.5	28	2	22
20411-16-06	M16X1.5	10	10	O08.0X1.5	28	2	22
20411-18-06	M18X1.5	10	12	O10.0X1.5	29	2.5	24
20411-18-08	M18X1.5	12	12	O10.0X1.5	30	2.5	24
20411-22-08	M22X1.5	12	15	O12.0X2.0	32	2.5	27
20411-26-10	M26X1.5	16	18	O15.0X2.0	35	2.5	32
20411-26-12	M26X1.5	20	18	O15.0X2.0	35	2.5	32
20411-27-12	M27X1.5	20	18	O15.0X2.0	35	2.5	32
20411-30-12	M30X2	20	22	O20.0X2.0	38	4	36
20411-18-05T	M18X1.5	8	12	O10.0X1.5	28	1.8	22
20411-22-05T	M22X1.5	8	15	O12.0X2.0	30	2.1	27
20411-22-06T	M22X1.5	10	D15	O12.0X2.0	29	2.5	27
20411-27-10T	M27X1.5	16	18	O15.0X2.0	28	2.5	32
20411-30-10T	M30X2	16	22	O20.0X2.0	35	4	36
20411-36-12T	M36X2	20	28	O26.0X2.0	35	4	41
20411-36-14T	M36X2	22	28	O26.0X2.0	36	4	41
20411-45-16T	M45X2	25	35	O32.0X2.5	41	5	55
20411-45-20T	M45X2	32	35	O32.0X2.5	42	5	55
20411-52-20T	M52X2	32	42	O38.0X2.5	44	5.5	60
20411-52-24T	M52X2	40	42	O38.0X2.5	44	5.5	60

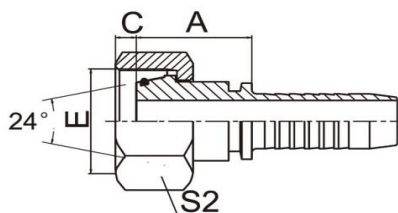

20411-T

F Metric L - 24° Cone with O-Ring - 45°
 45°公制内螺纹24°锥带O形圈轻系列

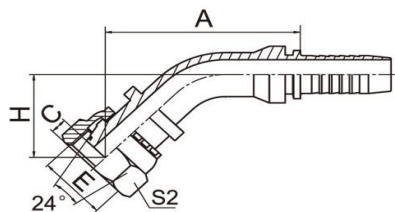

20441

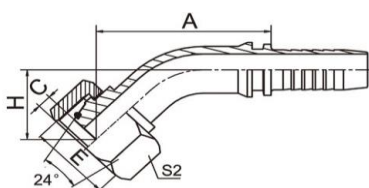

20441-T

PART NO 型号	THREAD	HOSE	TUBE	O-RING	DIMENSION			
	螺 纹	软管	硬管	O型圈	尺 寸			
	E	DN	OD	E	A	C	H	S2
20441-14-04	M14X1.5	6	8	O06.5X1.5	49	2	27	19
20441-16-05	M16X1.5	8	10	O08.0X1.5	51.5	2	28.5	22
20441-16-06	M16X1.5	10	10	O08.0X1.5	53.4	2	29.5	22
20441-18-06	M18X1.5	10	12	O10.0X1.5	54.2	2.5	29.9	24
20441-22-08	M22X1.5	12	15	O12.0X2.0	68.1	2.5	33.2	27
20441-26-10	M26X1.5	16	18	O15.0X2.0	80.7	2.5	35.9	32
20441-26-12	M26X1.5	20	18	O15.0X2.0	86.9	2.5	39.5	32
20441-27-12	M27X1.5	20	18	O15.0X2.0	86.9	2.5	39.5	32
20441-30-12	M30X2	20	22	O20.0X2.0	89.1	4	41.7	36
20441-18-05T	M18X1.5	8	12	O10.0X1.5	46.2	2.5	22.9	22
20441-22-05T	M22X1.5	8	15	O12.0X2.0	48.3	2.5	25	27
20441-22-06T	M22X1.5	10	15	O12.0X2.0	50.4	2.5	25.7	27
20441-26-08T	M26X1.5	12	18	O15.0X2.0	62	2.5	26.1	32
20441-27-10T	M27X1.5	16	18	O15.0X2.0	72	2.5	27.7	32
20441-30-10T	M30X2	16	22	O20.0X2.0	75.1	4	30.3	36
20441-36-12T	M36X2	20	28	O26.0X2.0	82	4	33.9	41
20441-36-14T	M36X2	22	28	O26.0X2.0	83.7	4	33.3	41
20441-45-20T	M45X2	32	35	O32.0X2.5	99.6	5.5	40.8	55
20441-52-20T	M52X2	32	42	O38.0X2.5	103	5.5	41.9	60
20441-52-24T	M52X2	40	42	O38.0X2.5	117	5.5	45.8	60

F Metric L - 24° Cone with O-Ring - 90°
 90°公制内螺纹24°锥带O形圈轻系列

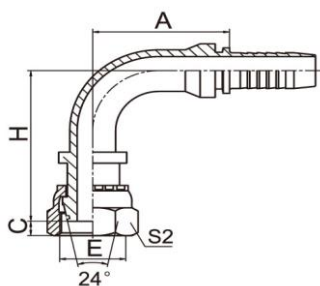

20491

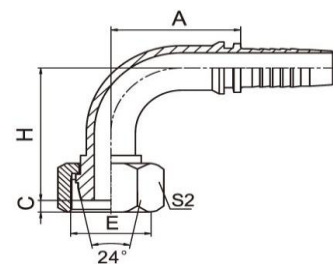

20491-T

PART NO 型号	THREAD	HOSE	TUBE	O-RING	DIMENSION			
	螺 纹	软管	硬管	O型圈	尺 寸			
	E	DN	OD	E	A	C	H	S2
20491-12-03	M12X1.5	5	6	O04.5X1.5	26.5	1	41.5	17
20491-12-04	M12X1.5	6	6	O04.5X1.5	30	1	44.5	17
20491-14-04	M14X1.5	6	8	O06.5X1.5	30	2	46	19
20491-16-04	M16X1.5	6	10	O08.0X1.5	30	2	46.5	22
20491-16-05	M16X1.5	8	10	O08.0X1.5	33	2	49.5	22
20491-16-06	M16X1.5	10	10	O08.0X1.5	35.3	2	51.8	22
20491-18-06	M18X1.5	10	12	O10.0X1.5	35.3	2.5	53.3	24
20491-22-08	M22X1.5	12	15	O12.0X2.0	41	2.5	61	27
20491-26-10	M26X1.5	16	18	O15.0X2.0	56.5	2.5	67.5	32
20491-27-12	M27X1.5	20	18	O15.0X2.0	65.5	2.5	77	32
20491-30-12	M30X2	20	22	O20.0X2.0	65.5	4	80	36
20491-18-05T	M18X1.5	8	12	O10.0X1.5	33	2.5	42	22
20491-22-06T	M22X1.5	10	15	O12.0X2.0	35.3	2.5	47.3	27
20491-26-08T	M26X1.5	12	18	O15.0X2.0	42	2.5	51	32
20491-27-10T	M27X1.5	16	18	O15X2.0	56.5	2.5	67.5	32
20491-30-10T	M30X2	16	22	O20.0X2.0	56.5	4	57.2	36
20491-36-12T	M36X2	20	28	O26.0X2.0	65.5	4	69	41
20491-36-14T	M36X2	22	28	O26.0X2.0	71.2	4	70	41
20491-45-16T	M45X2	25	35	O32.0X2.5	76.7	5	75	55
20491-45-20T	M45X2	32	35	O32.0X2.5	91.5	5	88.5	55
20491-52-20T	M52X2	32	42	O38.0X2.5	93	5.5	87	60
20491-52-24T	M52X2	40	42	O38.0X2.5	109	5.5	104	60

F Metric L - 24° Multi Seal
公制内螺纹24° 球面轻系列

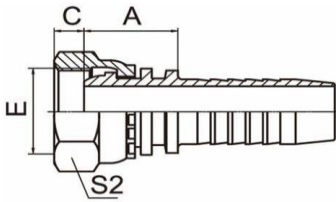

20411C

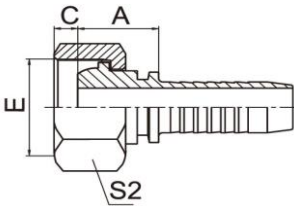

20411C-T

PART NO 型号	THREAD	HOSE		TUBE	DIMENSION		
	螺纹	软管		硬管	尺寸		
	E	DN	DASH	OD	A	C	S2
20411C-12-04	M12X1.5	6	04	6	19.5	3.5	17
20411C-14-04	M14X1.5	6	04	8	20.5	3.5	19
20411C-16-04	M16X1.5	6	04	10	21	3.5	22
20411C-16-05	M16X1.5	8	05	10	21	3.5	22
20411C-16-06	M16X1.5	10	06	10	21	3.5	22
20411C-18-06	M18X1.5	10	06	12	22.5	3	24
20411C-22-08	M22X1.5	12	08	15	24	4.5	27
20411C-30-12	M30X2	20	12	22	27	7	36
20411C-30-14	M30X2	22	14	22	27	7	36
20411C-36-16	M36X2	25	16	28	29	6.5	41
20411C-22-06T	M22X1.5	10	06	15	23.5	4.5	27
20411C-26-10T	M26X1.5	16	10	18	27	4	32
20411C-30-10T	M30X2	16	10	22	26.5	7	36
20411C-45-20T	M45X2	32	20	35	33	7	55
20411C-52-24T	M52X2	40	24	42	34	8	60

F Metric L - 24° Multi Seal - 45°
45°公制内螺纹24° 球面轻系列

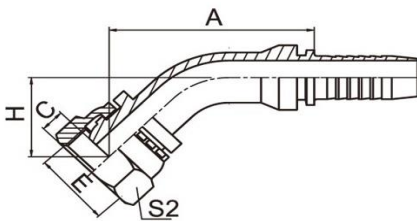

20441C

PART NO 型号	THREAD	HOSE	TUBE	DIMENSION			
	螺纹	软管	硬管	尺寸			
	E	DN	OD	A	C	H	S2
20441C-14-04	M14X1.5	6	8	44	3.5	22	19
20441C-16-04	M16X1.5	6	10	44.8	3.5	22.7	22
20441C-16-05	M16X1.5	8	10	46.6	3.5	23.2	22
20441C-16-06	M16X1.5	10	10	48.2	3.5	23.9	22
20441C-18-06	M18X1.5	10	12	50	3	25.7	24
20441C-22-08	M22X1.5	12	15	62.8	4.5	27.9	27
20441C-26-10	M26X1.5	16	18	75.1	4	30.6	32
20441C-30-12	M30X2	20	22	82	7	33.5	36
20441C-36-12T	M36X2	20	28	80.2	6.5	32.8	41

F Metric L - 24° Multi Seal - 90°
90°公制内螺纹24° 球面轻系列

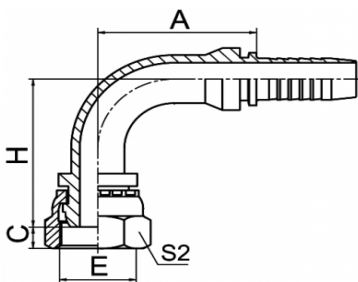

20491C

PART NO 型号	THREAD	HOSE	TUBE	DIMENSION			
	螺纹	软管	硬管	尺寸			
	E	DN	OD	A	C	H	S2
20491C-14-04	M14X1.5	6	8	30	3.5	39.5	19
20491C-16-04	M16X1.5	6	10	30	3.5	40	22
20491C-16-05	M16X1.5	8	10	33	3.5	43	22
20491C-16-06	M16X1.5	10	10	35.25	3.5	45.2	22
20491C-18-06	M18X1.5	10	12	35.25	3	47.25	24
20491C-22-08	M22X1.5	12	15	41	4.5	53	27
20491C-26-10	M26X1.5	16	18	56.5	4	60	32
20491C-30-12	M30X2	20	22	65.5	7	68.5	36
20491C-36-12T	M36X2	20	28	65.5	6.5	67.5	41

M Metric S - 24° Cone 公制外螺纹24°内锥面轻系列

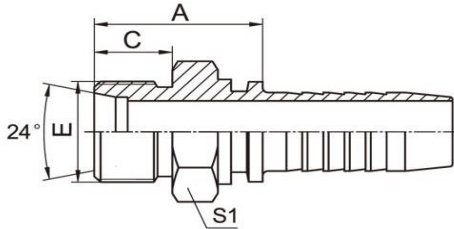

10511

PART NO 型号	THREAD	HOSE	TUBE	DIMENSION		
	螺 纹	软管	硬管	尺 寸		
	E	DN	OD	A	C	S1
10511-14-04	M14X1.5	6	6	24.1	12	14
10511-16-04	M16X1.5	6	8	26.5	12	17
10511-18-04	M18X1.5	6	10	26.5	12	19
10511-20-05	M20X1.5	8	12	27	12	22
10511-20-06	M20X1.5	10	12	26.5	12	22
10511-22-05	M22X1.5	8	14	30.5	14	24
10511-22-06	M22X1.5	10	14	30.5	14	24
10511-22-08	M22X1.5	12	14	31	14	24
10511-24-08	M24X1.5	12	16	31.5	14	27
10511-30-10	M30X2	16	20	36	16	32
10511-30-12	M30X2	20	20	36	16	32
10511-36-12	M36X2	20	25	40.5	18	41
10511-36-16	M36X2	25	25	41.5	18	38
10511-42-16	M42X2	25	30	44	20	46
10511-42-20	M42X2	32	30	45	20	46
10511-52-20	M52X2	32	38	50	22	55

F Metric S - 24° Cone with O-Ring 公制内螺纹24°内锥面轻系列

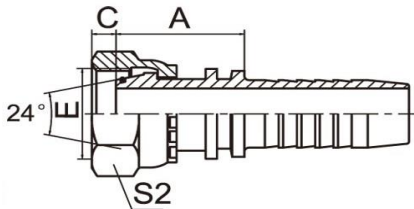

20511

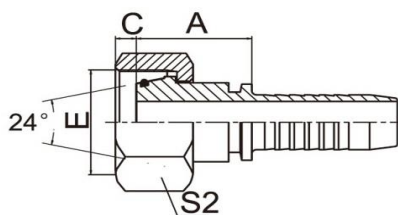

20511-T

PART NO 型号	THREAD	HOSE	TUBE	O-RING	DIMENSION		
	螺 纹	软管	硬管	O型圈	尺 寸		
	E	DN	OD	E	A	C	S2
20511-14-04	M14X1.5	6	6	O04.5X1.5	29	1.1	19
20511-16-04	M16X1.5	6	8	O06.5X1.5	29	1.5	22
20511-16-05	M16X1.5	8	8	O06.5X1.5	29	1.5	22
20511-18-06	M18X1.5	10	10	O08.0X1.5	29	2	24
20511-20-08	M20X1.5	12	12	O10.0X1.5	32	2.5	27
20511-22-08	M22X1.5	12	14	O11.0X2.0	32	2.5	27
20511-30-12	M30X2	20	20	O16.3X2.4	39	3	36
20511-18-04T	M18X1.5	6	10	O08.0X1.5	27	2	22
20511-20-06T	M20X1.5	10	12	O10.0X1.5	29	2.5	24
20511-22-06T	M22X1.5	10	14	O11.0X2.0	29	2.5	27
20511-24-08T	M24X1.5	12	16	O13.0X2.0	30	3	30
20511-30-10T	M30X2	16	20	O16.3X2.4	36	3	36
20511-36-12T	M36X2	20	25	O20.3X2.4	36	3	41
20511-36-14T	M36X2	22	25	O20.3X2.4	36	3	41
20511-42-12T	M42X2	20	30	O25.3X2.4	40	5	50
20511-42-16T	M42X2	25	30	O25.3X2.4	41	5	50
20511-52-20T	M52X2	32	38	O33.3X2.4	44	6.5	60
20511-52-24T	M52X2	40	38	O33.3X2.4	44	6.5	60

F Metric S - 24° Cone with O-Ring - 45°
45°公制内螺纹24°锥带O形圈重系列

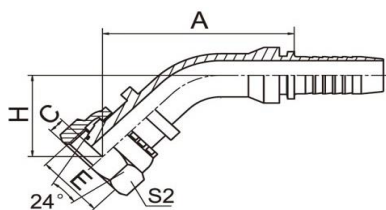

20541

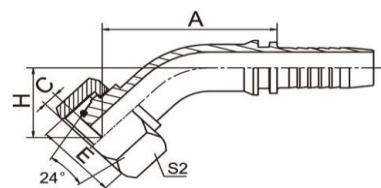

20541-T

PART NO 型号	THREAD	HOSE	TUBE	O-RING	DIMENSION				
	螺 纹	软管	硬管	O型圈	尺 寸				
	E	DN	OD	E	A	C	H	S2	
20541-14-04	M14.X1.5	6	6	O04.5X1.5	50.1	1.1	28	19	
20541-16-04	M16X1.5	6	8	O06.5X1.5	50.4	1.5	28.3	22	
20541-16-05	M16X1.5	8	8	O06.5X1.5	52.2	1.5	28.9	22	
20541-18-06	M18X1.5	10	10	O08.0X1.5	54.3	2	29.6	24	
20541-20-08	M20X1.5	12	12	O10.0X1.5	67.8	2.5	32.8	27	
20541-22-08	M22X1.5	12	14	O11.0X2.0	68.1	2.5	33.2	27	
20541-24-10	M24X1.5	16	16	O13.0X2.0	80.7	2.5	35.9	30	
20541-30-12	M30X2	20	20	O16.3X2.4	90.5	3	42.4	36	
20541-18-04T	M18X1.5	6	10	O08.0X1.5	43.4	2	21.3	22	
20541-20-06T	M20X1.5	10	12	O10.0X1.5	49.7	2.5	25	24	
20541-22-06T	M22X1.5	10	14	O11.0X2.0	49.6	2.5	25.3	27	
20541-24-08T	M24X1.5	12	16	O13.0X2.0	62.5	3	27.5	30	
20541-30-10T	M30X2	16	20	O16.3X2.4	75.8	3	31	36	
20541-36-12T	M36X2	20	25	O20.3X2.4	82.7	3	34.6	41	
20541-36-14T	M36X2	22	25	O20.3X2.4	84.4	3	34	41	
20541-42-16T	M42X2	25	30	O25.3X2.4	92.3	5	36.8	50	
20541-52-20T	M52X2	32	38	O33.3X2.4	103	6.5	41.2	60	
20541-52-24T	M52X2	40	38	O33.3X2.4	116	6.5	45.1	60	

F Metric S - 24° Cone with O-Ring - 90°
90°公制内螺纹24°锥带O形圈重系列

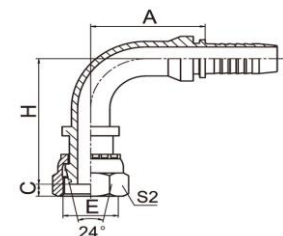

20591

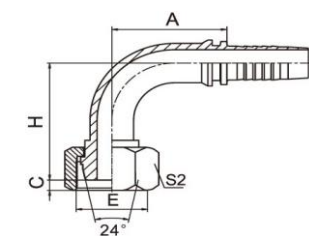

20591-T

PART NO 型号	THREAD	HOSE	TUBE	O-RING	DIMENSION				
	螺 纹	软管	硬管	O型圈	尺 寸				
	E	DN	OD	E	A	C	H	S2	
20591-14-04	M14.X1.5	6	6	O04.5X1.5	30	1.1	47.5	19	
20591-16-04	M16X1.5	6	8	O06.5X1.5	30	1.5	48	22	
20591-16-05	M16X1.5	8	8	O06.5X1.5	33	1.5	51	22	
20591-18-06	M18X1.5	10	10	O08.0X1.5	35.3	2	52.8	24	
20591-20-08	M20X1.5	12	12	O10.0X1.5	41	2.5	61	27	
20591-22-08	M22X1.5	12	14	O11.0X2.0	41	2.5	61	27	
20591-24-10	M24X1.5	16	16	O13.0X2.0	56.5	2.5	67.5	30	
20591-30-12	M30X2	20	20	O16.3X2.4	65.5	3	81	36	
20591-18-05T	M18X1.5	8	10	O08.0X1.5	33	2	52.8	24	
20591-22-06T	M22X1.5	10	14	O11.0X2.0	35.3	2.5	46.8	27	
20591-24-08T	M24X1.5	12	16	O13.0X2.0	41	3	53	30	
20591-30-10T	M30X2	16	20	O16.3X2.4	56.5	3	60.5	36	
20591-36-12T	M36X2	20	25	O20.3X2.4	66.2	3	70	41	
20591-36-14T	M36X2	22	25	O20.3X2.4	71.2	3	71	41	
20591-42-16T	M42X2	25	30	O25.3X2.4	78	5	77.5	50	
20591-52-20T	M52X2	32	38	O33.3X2.4	93	6.5	89	60	
20591-52-24T	M52X2	40	38	O33.3X2.4	109	6.5	103	60	

F Metric S - 24° Multi Seal 公制内螺纹24° 球面重系列

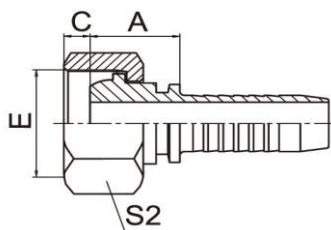

20511C-T

PART NO 型 号	THREAD	HOSE		TUBE	DIMENSION		
	螺 纹	软管	硬管	硬管	尺 寸		
	E	DN	DASH	OD	A	C	S2
20511C-18-04T	M18X1.5	6	4	10	21	3	22
20511C-20-05T	M20X1.5	8	5	12	21.5	4.5	24
20511C-20-06T	M20X1.5	10	6	12	21.5	4.5	24
20511C-22-06T	M22X1.5	10	6	14	21.5	4.5	27
20511C-24-08T	M24X1.5	12	8	16	23	5	30
20511C-30-10T	M30X2	16	10	20	26.5	7	36
20511C-36-12T	M36X2	20	12	25	27	6.5	41
20511C-42-16T	M42X2	25	16	30	29.5	9	50
20511C-52-20T	M52X2	32	20	38	34	8	60

F Metric S - 24° Multi Seal - 45° 45°公制内螺纹24° 球面重系列

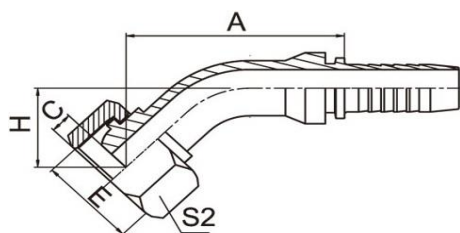

20541C-T

PART NO 型 号	THREAD	HOSE	TUBE	DIMENSION			
	螺 纹	软管	硬管	尺 寸			
	E	DN	OD	A	C	H	S2
20541C-16-04	M16X1.5	6	8	44.8	3	22.7	19
20541C-18-04T	M18X1.5	16	10	43.7	3	21.6	22
20541C-20-06T	M20X1.5	10	12	48.9	4.5	24.6	24
20541C-24-08T	M24X1.5	12	16	61.4	2.5	26.5	30

F Metric S - 24° Multi Seal - 90° 90°公制内螺纹球面重系列

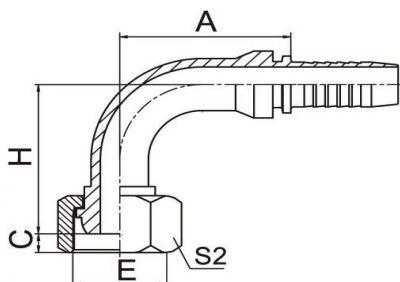

20591C-T

PART NO 型 号	THREAD	HOSE	TUBE	DIMENSION			
	螺 纹	软管	硬管	尺 寸			
	E	DN	OD	A	C	H	S2
20591C-16-04	M16X1.5	6	8	30	3	40	22
20591C-18-04T	M18X1.5	6	10	30	3	38.5	22
20591C-20-05T	M20X1.5	8	12	33	4.5	42	24
20591C-20-06T	M20X1.5	10	12	35.3	4.5	45.7	24
20591C-22-06T	M22X1.5	10	14	35.3	4.5	44.7	27
20591C-24-08T	M24X1.5	12	16	41	5	52	30
20591C-30-10T	M30X2	16	20	56.5	7	56.5	36
20591C-36-12T	M36X2	20	25	65.5	6.5	66.5	41
20591C-42-16T	M42X2	25	30	78	9	73.5	50
20591C-52-20T	M52X2	32	38	93	8	87.5	60

M Metric - 60° Cone or Bonded Seal
公制外螺纹60°内锥面或六角端面用组合垫密封的双用接头

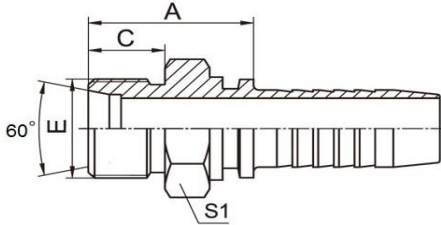

10611

PART NO 型号	THREAD	HOSE		DIMENSION		
	螺纹	软管		尺寸		
	E	DN	DASH	A	C	S1
10611-14-04	M14X1.5	6	4	23.5	11	19
10611-14-06	M14X1.5	10	6	24	11	19
10611-16-04	M16X1.5	6	4	27.5	12	22
10611-16-05	M16X1.5	8	5	26.5	12	22
10611-18-06	M18X1.5	10	6	29.5	12	24
10611-22-06	M22X1.5	10	6	30.5	14	27
10611-22-08	M22X1.5	12	8	32	14	27
10611-24-10	M24X1.5	16	10	35	14	30
10611-26-10	M26X1.5	16	10	35	16	32
10611-27-10D	M27X1.5	16	10	35	16	32
10611-27-10	M27X2	16	10	37	18	32
10611-30-12D	M30X1.5	20	12	38	18	36
10611-30-12	M30X2	20	12	38	18	36
10611-33-16	M33X2	25	16	43	20	46
10600-42-20	M42X2	32	20	46	20	50
10611-45-20	M45X2	32	20	46	20	55
10611-48-24	M48X2	40	24	46	20	55
10611-52-24	M52X2	40	24	48	20	60

F Metric - 60° Cone
公制内螺纹60°外锥面

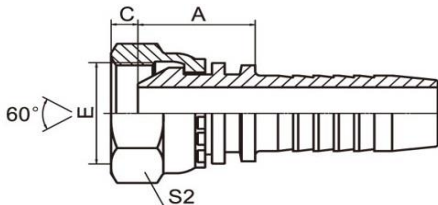

20611

PART NO 型号	THREAD	HOSE		DIMENSION		
	螺纹	软管		尺寸		
	E	DN	DASH	A	C	S2
20611-14-04	M14X1.5	6	4	18	5.5	19
20611-16-05	M16X1.5	8	5	19	5.5	22
20611-16-06	M16X1.5	10	6	19	5.5	22
20611-18-06	M18X1.5	10	6	20	5.5	24
20611-20-08	M20X1.5	12	8	22	6.5	27
20611-22-08	M22X1.5	12	8	22.5	6	27
20611-24-10	M24X1.5	16	10	24.5	6.5	30
20611-26-10	M26X1.5	16	10	25.5	6	32
20611-30-10D	M30X1.5	16	10	26.5	6	36
20611-30-12D	M30X1.5	20	12	26.5	6	36
20611-30-12	M30X2	20	12	26.5	6	36
20611-36-16	M36X2	25	16	30	6.5	41
20611-27-10DT	M27X1.5	16	10	25.5	6	32
20611-27-10T	M27X2	16	10	25.5	6	32
20611-39-16T	M39X2	25	16	30	6.5	46
20611-45-20T	M45X2	32	20	31	8.5	55
20611-52-24T	M52X2	40	24	32	10	60

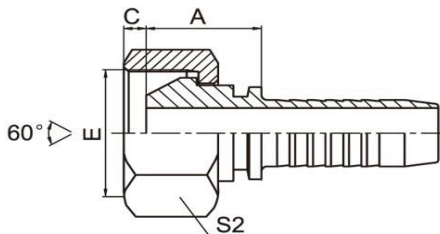

20611-T

F Metric - 60° Cone - 45°
 45°公制内螺纹60°外锥面

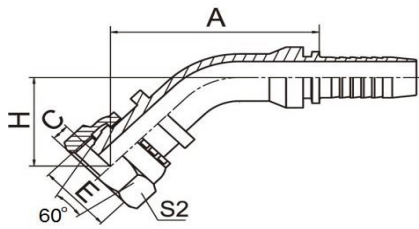

20641

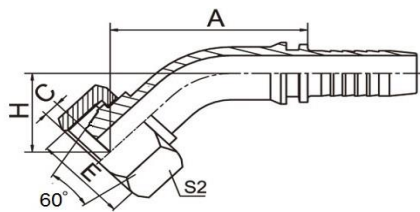

20641-T

PART NO 型号	THREAD	HOSE		DIMENSION			
	螺纹	软管		尺寸			
	E	DN	DASH	A	C	H	S2
20641-14-04	M14X1.5	6	04	42.7	5.5	20.6	19
20641-16-05	M16X1.5	8	05	45.1	5.5	21.8	22
20641-18-06	M18X1.5	10	06	47.4	5.5	23.2	24
20641-22-08	M22X1.5	12	08	61.8	6	26.8	27
20641-30-12D	M30X1.5	20	12	81.6	6	33.5	36
20641-27-10DT	M27X1.5	16	10	71.4	6	27.1	32
20641-36-14T	M36X2	22	14	81.9	6.5	31.6	41
20641-39-16T	M39X2	25	16	88.5	6.5	34.3	46
20641-45-20T	M45X2	32	20	99.1	8.5	38.4	55
20641-52-24T	M52X2	40	24	113.4	10	42.7	60

F Metric - 60° Cone - 90°
 90°公制内螺纹60°外锥面

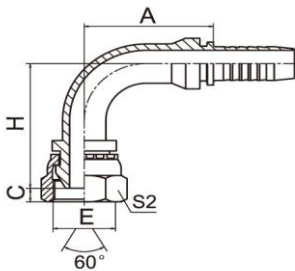

20691

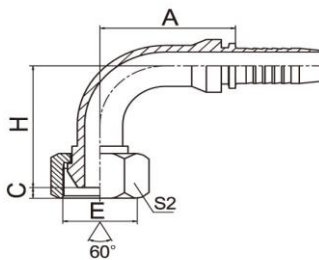

20691-T

PART NO 型号	THREAD	HOSE		DIMENSION			
	螺纹	软管		尺寸			
	E	DN	DASH	A	C	H	S2
20691-14-04	M14X1.5	6	4	30	5.5	37	19
20691-16-05	M16X1.5	8	5	33	5.5	40.5	22
20691-18-06	M18X1.5	10	6	35.3	5.5	43.8	24
20691-22-08	M22X1.5	12	8	41	6	52	27
20691-30-12D	M30X1.5	20	12	66.2	6	68.5	36
20691-36-16	M36X2	25	16	78	6.5	76.5	41
20691-27-10DT	M27X1.5	16	10	56	6	55	32
20691-36-14T	M36X2	22	14	71.2	6.5	67.5	41
20691-39-16T	M39X2	25	16	76.7	6.5	74	46
20691-45-20T	M45X2	32	20	91.5	8.5	85	55
20691-52-24T	M52X2	40	24	109.4	10	99	60

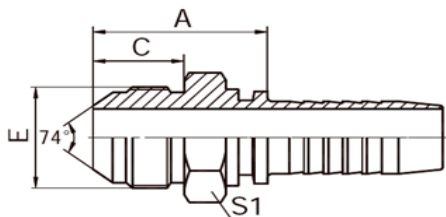
M Metric - 74° Cone Seal
国标公制外螺纹74°外锥面

10711

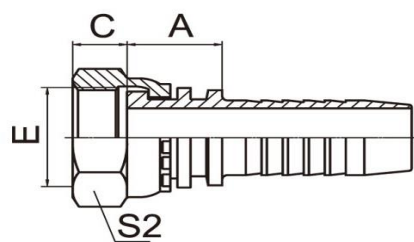
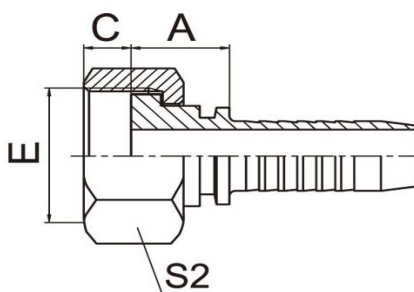
PART NO 型号	THREAD	HOSE		DIMENSION		
	螺纹	软管		尺寸		
	E	DN	DASH	A	C	S1
10711-14-04	M14X1.5	6	04	30.5	18	17
10711-14-06	M14X1.5	10	06	30.5	18	17
10711-16-05	M16X1.5	8	05	31.5	19	17
10711-16-06	M16X1.5	10	06	31.5	19	17
10711-18-06	M18X1.5	10	06	31.5	19	19
10711-22-08	M22X1.5	12	08	35	19.5	22
10711-24-08	M24X1.5	12	08	37	20	24
10711-27-10	M27X1.5	16	10	38.5	20.5	27
10711-30-12	M30X1.5	20	12	42.5	23	32
10711-33-12	M33X2	20	12	45	26	36
10711-36-14	M36X2	22	14	45	26	38
10711-39-16	M39X2	25	16	48	27.5	41
10711-42-20	M42X2	32	20	52	28.5	46
10711-45-20	M45X2	32	20	52	28.5	46

F Metric - 74° Cone Seal
国标公制内螺纹74°内锥面

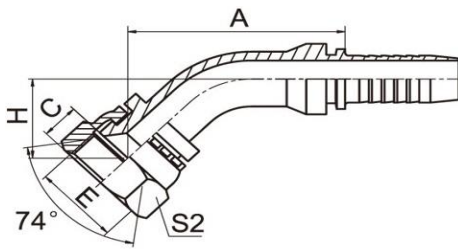
20711

20711-T

PART NO 型号	THREAD	HOSE		DIMENSION		
	螺纹	软管		尺寸		
	E	DN	DASH	A	C	S2
20711-12-04	M14X1.5	6	4	14.5	10	17
20711-14-04	M14X1.5	6	4	15.5	8.5	19
20711-14-05	M14X1.5	8	5	15.5	8.5	19
20711-14-06	M14X1.5	10	6	15.5	8.5	19
20711-16-04	M16X1.5	6	4	16.5	8	22
20711-16-05	M16X1.5	8	5	16.5	8	22
20711-16-06	M16X1.5	10	6	16	8	22
20711-18-06	M18X1.5	10	6	17.5	10	24
20711-20-08	M20X1.5	12	8	18.5	10	27
20711-22-08	M22X1.5	12	8	18.5	10	27
20711-22-10	X22X1.5	16	10	19.5	10	27
20711-27-12	M27X1.5	20	12	21.5	11	32
20711-30-12	M30X1.5	20	12	21.5	11	36
20711-33-14	M33X2	22	14	21.5	13	41
20711-36-16	M36X2	25	16	23	14	41
20711-42-20	M42X2	32	20	26	15	50
20711-18-05T	M18X1.5	8	5	16	8	22
20711-20-06T	M20X1.5	10	6	16	10	24
20711-22-06T	M22X1.5	10	6	16	10	27
20711-24-08T	M24X1.5	12	8	16.5	11	30
20711-27-08T	M27X1.5	12	8	18.5	11	32
20711-27-10T	M27X1.5	16	10	19.5	11	32
20711-30-10T	M30X1.5	16	10	18.5	11	36
20711-33-10T	M33X2	16	10	20	13	41
20711-33-12T	M33X2	20	12	20	13	41
20711-36-12T	M36X2	20	12	20	14	41
20711-36-14T	M36X2	22	14	20	14	41
20711-39-16T	M39X2	25	16	23.5	14	46
20711-42-16T	M42X2	25	16	23.5	15	50
20711-45-20T	M45X2	32	20	25	15	55
20711-52-24T	M52X2	40	24	25	17	60

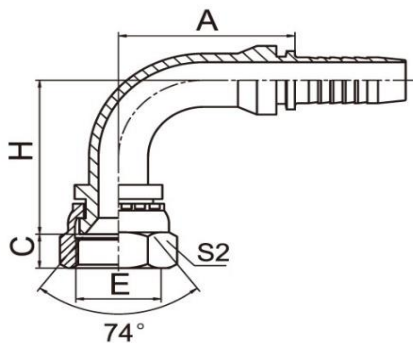
F Metric - 74° Cone Seal - 45°
45°国标公制内螺纹74°内锥面

20741

PART NO 型号	THREAD 螺纹	HOSE 软管		DIMENSION 尺寸			
	E	DN	DASH	A	C	H	S2
20741-14-04	M14X1.5	6	04	40.5	8.5	18.5	19
20741-16-05	M16X1.5	8	05	44.4	8	20	22
20741-18-06	M18X1.5	10	06	45.7	10	21.4	24
20741-22-08	M22X1.5	12	08	58.9	10	24	27
20741-27-10	M27X1.5	16	10	71.2	11	26.4	32
20741-30-12	M30X1.5	20	12	78.1	11	30	36
20741-33-12	M33X2	20	12	77.4	13	30	41
20741-33-16	M33X2	25	16	85	13	30.8	41
20741-36-14	M36X2	22	14	79.8	14	29.6	41
20741-36-16	M36X2	25	16	85.7	14	31.5	41
20741-39-16	M39X2	25	16	86.1	14	31.8	46
20741-45-20W	M45X2	32	20	97	15	36.2	55
20741-52-24W	M52X2	40	24	112.9	17	40.9	60

F Metric - 74° Cone Seal - 90°
90°国标公制内螺纹74°内锥面

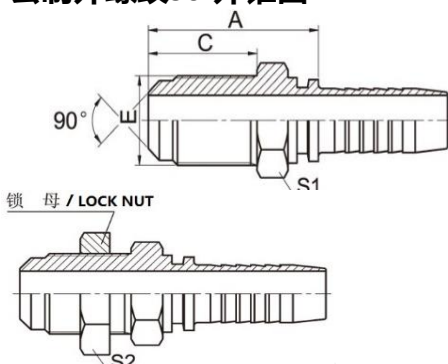
20791

PART NO 型号	THREAD 螺纹	HOSE 软管		DIMENSION 尺寸			
	E	DN	DASH	A	C	H	S2
20791-12-04C	M12X1.5	6	4	30	9	33.5	17
20791-12-04	M12X1.5	6	4	30	10	33.5	17
20791-14-04	M14X1.5	6	4	30	8.5	34	19
20791-16-04	M16X1.5	6	4	30	8	35	22
20791-16-05	M16X1.5	8	5	34	8	38	22
20791-18-06	M18X1.5	10	6	35.3	10	41.3	24
20791-22-08	M22X1.5	12	8	41	10	48	27
20791-22-10	M22X1.5	16	10	56.5	10	52.5	27
20791-27-10	M27X1.5	16	10	56.5	11	54	32
20791-30-12	M30X1.5	20	12	66.2	11	63.5	36
20791-33-12	M33X2	20	12	65.5	13	63.5	41
20791-33-16	M33X2	25	16	76.7	13	69	41
20791-36-12	M36X2	20	12	65.5	14	63.5	41
20791-36-14	M36X2	22	14	71.2	14	64.5	41
20791-39-16	M39X2	25	16	76.7	14	70.5	46
20791-45-20W	M45X2	32	20	91.5	15	83	55
20791-52-20W	M52X2	32	20	93	17	84.5	60
20791-52-24W	M52X2	40	24	110.7	17	96.5	60

M Metric - 90° Cone Seal
公制外螺纹90°外锥面

10811L-LN

PART NO 型号	THREAD 螺纹	HOSE 软管		DIMENSION 尺寸			
	E	DN	DASH	A	C	S1	S2
10811L-12-04	M12X1.5	6	04	46	34	17	17
10811L-14-04	M14X1.5	6	04	46	34	17	19
10811L-14-06	M14X1.5	10	06	46.5	34	17	19
10811L-16-04	M16X1.5	6	04	46.5	34	19	22
10811L-16-06	M16X1.5	10	06	46.5	34	22	22
10811L-20-06	M20X1.5	10	06	57	40	27	27
10811L-20-08	M20X1.5	12	08	57.5	40	27	27
10811L-22-08	M22X1.5	12	08	62.5	45	27	27

* Please insert suffix "LN" after part no if you want to order with locknut.

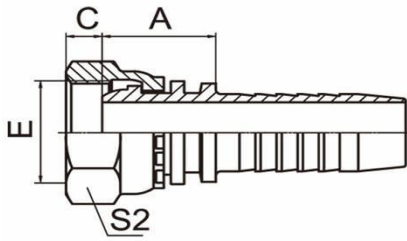
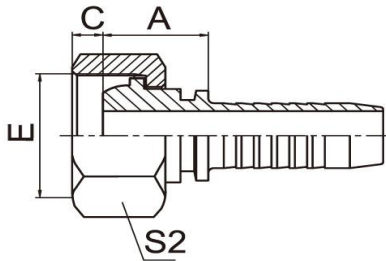
* 如需带锁母订货, 请在货号后加上"LN", 例如: 10811L-12-04LN

F Metric - Multi Seal
公制内螺纹球面

20111

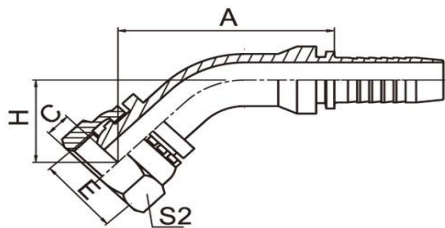
20111-T

PART NO 型号	THREAD	HOSE		DIMENSION		
	螺纹	软管		尺寸		
	E	DN	DASH	A	C	S1
20111-10-04	M10X1	6	04	18	2.5	14
20111-12-04	M12X1.5	6	04	18.5	4	17
20111-12-05	M12X1.5	8	05	18.5	4	17
20111-14-04	M14X1.5	6	04	19.5	4.5	19
20111-14-05	M14X1.5	8	05	19.5	4.5	19
20111-16-04	M16X1.5	6	04	19.5	4.5	22
20111-16-05	M16X1.5	8	05	20	4.5	22
20111-16-06	M16X1.5	10	06	20	4.5	22
20111-18-06	M18X1.5	10	06	21.5	4	24
20111-18-08	M18X1.5	12	08	22	4	24
20111-20-08	M20X1.5	12	08	23	5.5	27
20111-22-08	M22X1.5	12	08	23.5	5	27
20111-22-10	M22X1.5	16	10	24.5	5	27
20111-24-10	M24X1.5	16	10	26	5	30
20111-30-12	M30X2	20	12	26.5	7	36
20211-18-05T	M18X1.5	8	05	21.5	4	24
20211-20-06T	M20X1.5	10	06	20.5	5.5	24
20211-22-06T	M22X1.5	10	06	23	5	27
20211-24-08T	M24X1.5	12	08	22	5.5	30
20211-27-10T	M27X2	16	10	23.5	7	32
20211-36-12T	M36X2	20	12	26	7	41
20211-36-14T	M36X2	22	14	26	7	41
20211-39-14T	M39X2	22	14	28.5	7	46
20211-39-16T	M39X2	25	16	29.5	7	46
20211-42-16T	M42X2	25	16	30	8.5	50
20211-45-20T	M45X2	32	20	31.5	8.5	55
20211-52-20T	M52X2	32	20	33	9	60
20211-52-24T	M52X2	40	24	33	9	60
20211-64-32T	M64X2	50	32	35	14	75

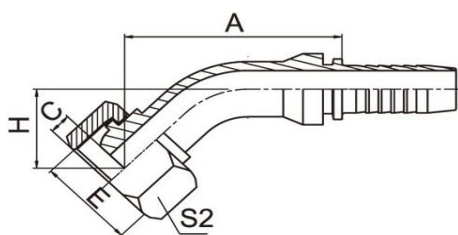
F Metric - Multi Seal - 45°
45°公制内螺纹球面

20141

PART NO 型号	THREAD	HOSE		DIMENSION			
	螺纹	软管		尺寸			
	E	DN	DASH	A	C	H	S2
20141-10-04	M10X1	6	4	43.2	2.5	21.5	14
20141-12-03	M12X1.5	5	3	40.9	4	21.2	17
20141-12-04	M12X1.5	6	4	43	4	22	17
20141-14-04	M14X1.5	6	4	43.4	4.5	21.3	19
20141-14-05	M14X1.5	8	5	45.5	4.5	22.2	19
20141-16-04	M16X1.5	6	4	43.7	4.5	21.4	22
20141-16-05	M16X1.5	8	5	45.8	4.5	22.5	22
20141-16-06	M16X1.5	10	6	47.4	4.5	24.1	22
20141-18-06	M18X1.8	10	6	48.5	4	24.2	24
20141-18-08	M18X1.8	12	8	52.2	4	25.7	24
20141-20-08	M20X1.5	12	8	62.1	5.5	27.2	27
20141-22-08	M22X1.5	12	8	62.1	5	27.2	27
20141-24-10	M24X1.5	16	10	75.4	5	29.6	30
20141-30-12	M30X2	20	12	80.9	6	33.5	36

F Metric - Multi Seal - 45°
45°公制内螺纹球面

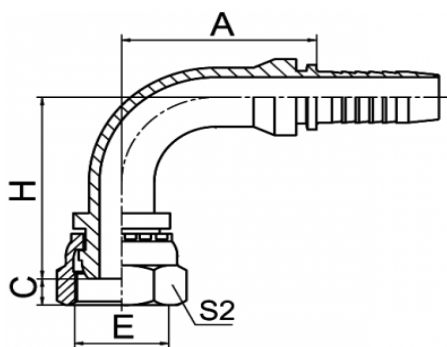
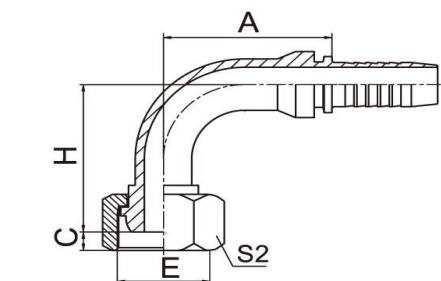
20141-T

PART NO 型号	THREAD 螺纹	HOSE 软管		DIMENSION 尺寸			
	E	DN	DASH	A	C	H	S2
20141-18-05T	M18X1.5	8	05	46.8	4	22.6	24
20141-20-06T	M20X1.5	10	06	48.2	5.5	23.9	27
20141-22-06T	M22X1.5	10	06	58.4	5	25.7	27
20141-24-08T	M24X1.5	12	08	61.1	5.5	26.1	30
20141-27-10DT	M27X1.5	16	10	74.4	5.5	29.6	32
20141-27-10T	M27X2	16	10	74.4	5.5	29.6	32
20141-36-14T	M36X2	22	14	83	7	32.64	41
20141-39-16T	M39X2	25	16	88.2	7	33.95	46
20141-45-20T	M45X2	32	20	99.1	8.5	38.4	55
20141-52-24T	M52X2	40	24	114.1	9	43.4	60

F Metric - Multi Seal - 90°
90°公制内螺纹球面

20191

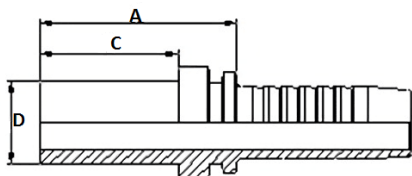
20191-T

PART NO 型号	THREAD 螺纹	HOSE 软管		DIMENSION 尺寸			
	E	DN	DASH	A	C	H	S2
20191-10-03	M10X1	5	3	27	2.5	35.5	14
20191-12-04	M12X1.5	6	4	30	4	37.5	17
20191-14-04	M14X1.5	6	4	30	4.5	38	19
20191-14-05	M14X1.5	8	5	33	4.5	41	19
20191-16-04	M16X1.5	6	4	30	4.5	38.5	19
20191-16-05	M16X1.5	8	5	33	4.5	41.5	22
20191-18-06	M18X1.5	10	6	35.3	4	45.3	24
20191-18-08	M18X1.5	12	8	40.5	4	50.5	24
20191-20-08	M20X1.5	12	8	41	5.5	52	27
20191-22-08	M22X1.5	12	8	41	5	52.5	27
20191-24-10	M24X1.5	16	10	58	5	58.5	30
20191-30-12D	M30X1.5	20	12	67.5	6	68.5	36
20191-30-12	M30X2	20	12	67.5	6	68.5	36
20191-18-05T	M18X1.5	8	5	33	4	43	24
20191-20-06T	M20X1.5	10	6	35.3	5.5	44.8	24
20191-22-06T	M22X1.5	10	6	35.8	5	76.8	27
20191-24-08T	M24X1.5	12	8	41	5.5	51	30
20191-27-10DT	M27X1.5	16	10	56	5.5	55.5	32
20191-27-10T	M27X2	16	10	56	5.5	55.5	32
20191-36-12T	M36X2	20	12	65.5	7	68	41
20191-36-14T	M36X2	22	14	71.2	7	69	41
20191-39-16T	M39X2	25	16	76.7	7	73.5	46
20191-45-20T	M45X2	32	20	91.5	8.5	85	55
20191-52-24T	M52X2	40	24	109.4	9	100	60
20191-64-32T	M64X2	50	32	131.8	14	122.3	75

Metric Standpipe
卡套式直管



50011

PART NO 型号	TUBE OD	HOSE		DIMENSION		NOTE 备注	
	管子外径	软管		尺寸			
	D	DN	DASH	A	C		L/S
50011-06-03	6	5	3	28.5	22	L. T. 轻系列	
50011-06-04	6	6	4	29	22		
50011-10-05	10	8	5	31	23		
50011-10-06	10	10	6	32	23		
50011-12-06	12	10	6	33.5	23		
50011-12-08	12	12	8	33	23		
50011-15-06	15	10	6	35.5	25		
50011-15-08	15	12	8	35.5	25		
50011-18-08	18	12	8	36.5	26		
50011-18-10	18	16	10	41	26		
50011-22-10	22	16	10	44	28		
50011-22-16	22	25	16	46	28		
50011-28-06	28	25	16	47	30		
50011-35-20	35	32	20	56	36		
50011-42-24	42	40	24	62	40		
50011-08-04	8	6	4	31	24		S. T. 重系列
50011-08-05	8	8	5	33	24		
50011-08-06	8	10	6	33	24		
50011-10-04	10	6	4	35	26		
50011-12-04	12	6	4	34.5	26		
50011-12-05	12	8	5	35.5	26		
50011-14-06	14	10	6	39.5	29		
50011-14-08	14	12	8	40	29		
50011-14-12	14	20	12	45.5	29		
50011-16-08	16	12	8	41	30		
50011-16-10	16	16	10	45.5	30		
50011-20-10	20	16	10	52.5	36		
50011-20-12	20	20	12	52.5	36		
50011-25-12	25	20	12	56	40		
50011-25-16	25	25	16	57	40		
50011-30-10	30	25	16	63	44		
50011-30-20	30	32	20	64	44		
50011-38-16	38	25	16	69	50		
50011-38-20	38	32	20	70	50		

Metric Standpipe - 45°
45°卡套式直管

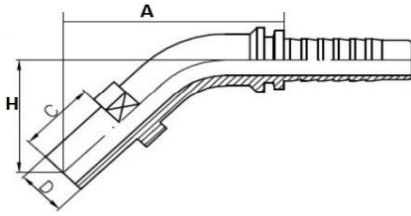

50041

PART NO 型号	TUBE OD	HOSE		DIMENSION			NOTE	
	管子外径	软管		尺寸			备注	
	D	DN	DASH	A	C	H	L/S	
50041-06-03	6	5	3	47.8	22	27.5	L. T. 轻系列	
50041-06-04	6	6	4	52.2	22	30.1		
50041-08-05	8	8	5	55.7	24	32.4		
50041-08-06	8	10	6	57.9	24	33.1		
50041-10-05	10	8	5	54	23	30.6		
50041-10-06	10	10	6	56.1	23	31.3		
50041-12-06	12	10	6	58.5	23	34.5		
50041-12-08	12	12	8	72.4	23	37.4		
50041-15-06	15	10	6	59.3	25	34.5		
50041-15-08	15	12	8	70.6	25	35.7		
50041-18-08	18	12	8	73.4	26	38.5		
50041-18-10	18	16	10	84.6	26	39.8		
50041-22-10	22	16	10	87.1	28	42.3		
50041-22-12	22	20	12	93.3	28	45.9		
50041-22-16	22	25	16	100.9	28	46.7		
50041-28-16	28	25	16	103.7	30	49.5		
50041-35-20	35	32	20	118.5	36	57.8		
50041-08-04	8	6	4	53.6	24	31.5		S. T. 重系列
50041-10-04	10	6	4	54	26	31.9		
50041-12-04	12	6	4	57.1	26	35.1		
50041-12-05	12	8	5	59.2	26	35.9		
50041-14-06	14	10	6	61.6	29	37.3		
50041-14-08	14	12	8	73.8	29	38.8		
50041-14-12	14	20	12	91.9	29	43.8		
50041-16-08	16	12	8	76.6	30	41.7		
50041-16-10	16	16	10	87.8	30	43		
50041-20-10	20	16	10	92.8	36	48		
50041-20-12	20	20	12	100.7	36	52.6		
50041-25-12	25	20	12	101.8	40	54.4		
50041-25-16	25	25	16	109.4	40	55.2		
50041-30-16	30	25	16	113.6	44	59.4		
50041-30-20	30	32	20	124.2	44	63.5		
50041-38-16	38	25	16	117.9	50	63.6		
50041-38-20	38	32	20	128.4	50	67.7		

Metric Standpipe - 45°
45°卡套式直管

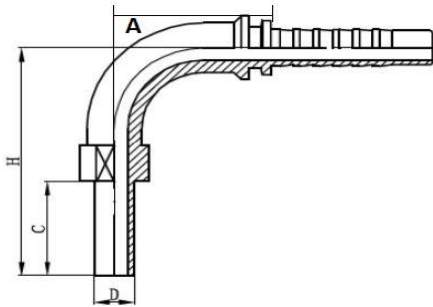

50091

PART NO 型号	TUBE OD	HOSE		DIMENSION			NOTE
	管子外径	软管		尺寸			备注
	D	DN	DASH	A	C	H	L/S
50091-06-03	6	5	3	26.5	22	45	
50091-06-04	6	6	4	30	22	48	
50091-08-05	8	8	5	34	24	55.5	
50091-08-06	8	10	6	35.8	24	57.8	
50091-10-05	10	8	5	34	23	53	
50091-10-06	10	10	6	35.3	23	55.3	
50091-12-06	12	10	6	35.3	23	59.8	
50091-12-08	12	12	8	41	23	67	L. T.
50091-15-06	15	10	6	35.8	25	59.8	轻系列
50091-15-08	15	12	8	41	25	65	
50091-18-08	18	12	8	41	26	68.5	
50091-18-10	18	16	10	56.5	26	73	
50091-22-10	22	16	10	56.5	28	76.5	
50091-22-12	22	20	12	65.5	28	86	
50091-22-16	22	25	16	76.7	28	91.5	
50091-28-16	28	25	16	76.7	30	95.5	
50091-35-20	35	32	20	91.5	36	112.5	
50091-08-04	8	6	4	30	24	52.5	
50091-10-04	10	6	4	30	26	53	
50091-12-04	12	6	4	30	26	57.5	
50091-12-05	12	8	5	33	26	60.5	
50091-14-06	14	10	6	35.3	29	63.8	
50091-14-08	14	12	8	41	29	69	
50091-14-12	14	20	12	66.2	29	83	
50091-16-08	16	12	8	42	30	73	
50091-16-10	16	16	10	56.5	30	77.5	S. T.
50091-20-10	20	16	10	56.5	36	84.5	重系列
50091-20-12	20	20	12	65.5	36	95.5	
50091-25-12	25	20	12	65.5	40	98	
50091-25-16	25	25	16	76.7	40	103.5	
50091-30-16	30	25	16	78	40	109.5	
50091-30-20	30	32	20	91.5	44	120.5	
50091-38-16	38	25	16	76.7	50	115.5	
50091-38-20	38	32	20	91.5	50	126.5	

Metric Retaining Nuts 公制卡套螺母

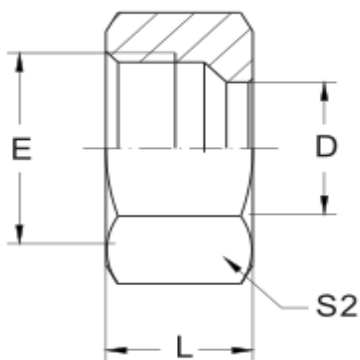

NL/NS

PART NO 型 号	THREAD	TUBE O.D	DIMENSION		W. P.
	螺 纹	管子直径	尺 寸		工作压力
	E	D	L	S2	Mpa
NL-12	M12X1.5	6	14.5	14	50
NL-14	M14X1.5	8	14.5	17	50
NL-16	M16X1.5	10	15.5	19	50
NL-18	M18X1.5	12	15.5	22	50
NL-22	M22X1.5	15	17	27	40
NL-26	M26X1.5	18	18	32	40
NL-30	M30X2	22	20	36	40
NL-36	M36X2	28	21	41	25
NL-45	M45X2	35	24	50	25
NL-52	M52X2	42	24	60	25
NS-14	M14X1.5	6	16.5	17	80
NS-16	M16X1.5	8	16.5	19	80
NS-18	M18X1.5	10	17.5	22	80
NS-20	M20X1.5	12	17.5	24	63
NS-22	M22X1.5	14	20.5	27	63
NS-24	M24X1.5	16	20.5	30	63
NS-30	M30X2	20	24	36	42
NS-36	M36X2	25	27	46	42
NS-42	M42X2	30	29	50	42
NS-52	M52X2	38	32.5	60	42

* NL is used with L. T.; NS is used with S. T.
* NL适用于轻型，NS适用于重型

Metric Cutting Ring 公制卡套

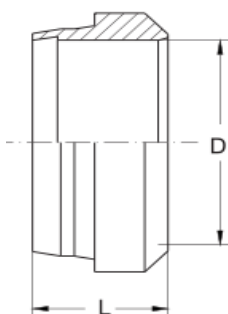

RL/RS

PART NO 型 号	TUBE O.D	DIMENSION	W. P.	NOTE
	管子直径	尺 寸	工作压力	备注
	D	L	Mpa	L/S
RL-06	6	9.5	50	L. T. 轻系列
RL-08	8	9.5	50	
RL-10	10	10	50	
RL-12	12	10	50	
RL-15	15	10	40	
RL-18	18	10	40	
RL-22	22	10.5	40	
RL-28	28	11	25	
RL-35	35	13.5	25	S. T. 重系列
RL-42	42	13	25	
RS-06	6	9.5	80	
RS-08	8	9.5	80	
RS-10	10	10	80	
RS-12	12	10	63	
RS-14	14	10	63	
RS-16	16	10.5	63	
RS-20	20	12.5	42	
RS-25	25	12.5	42	
RS-30	30	13	42	
RS-38	38	13	42	

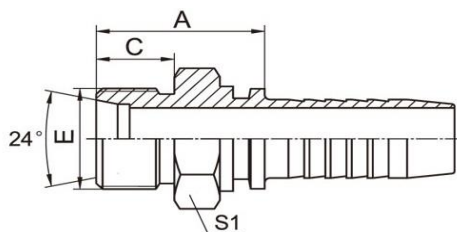
M BSP - Flat Seal with O-Ring
英管外螺纹O形圈密封

12211

PART NO 型号	THREAD	HOSE		O-RING	DIMENSION		
	螺纹	软管		O型圈	尺寸		
	E	DN	DASH	O	A	C	S1
12211-04-04	G1/4"X19	6	4	O111	24	11	19
12211-04-06	G1/4"X19	10	6	O111	24	11	19
12211-06-06	G3/8"X19	10	6	O113	27	12	22
12211-08-04	G1/2"X14	6	4	O115	34	14	27
12211-08-06	G1/2"X14	10	6	O115	34	14	27
12211-08-08	G1/2"X14	12	8	O115	34	14	27
12211-10-10	G5/8"X14	16	10	O910	36	16	30
12211-12-10	G3/4"X14	16	10	O119	34	16	32
12211-12-12	G3/4"X14	20	12	O119	38	16	32
12211-12-16	G3/4"X14	25	16	O119	36	16	32
12211-16-16	G1"X11	25	16	O217	45	19	41
12211-20-20	G1.1/4"X11	32	20	O222	46	20	50

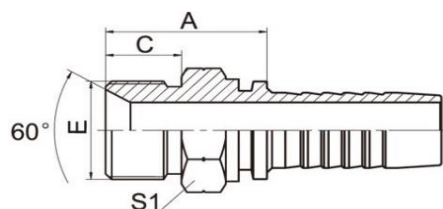
BSP 60° CONE SEAL SERIES 英管螺纹60°锥面密封系列

M BSP - 60° Cone Seal
英管外螺纹60°内锥面

12611

PART NO 型号	THREAD	HOSE		DIMENSION		
	螺纹	软管		尺寸		
	E	DN	DASH	A	C	S1
12611-02-03	G1/8"X28	5	3	22	10	12
12611-04-04	G1/4"X19	6	4	24.5	12	14
12611-06-05	G3/8"X19	8	5	26	14	17
12611-06-06	G3/8"X19	10	6	27.5	14	17
12611-06-08	G3/8"X19	12	8	26.5	14	19
12611-08-06	G1/2"X14	10	6	30.5	16	22
12611-08-08	G1/2"X14	12	8	31	16	22
12611-10-08	G5/8"X14	12	8	32.5	18	24
12611-10-10	G5/8"X14	16	10	33.5	18	24
12611-12-08	G3/4"X14	12	8	35.5	19	27
12611-12-10	G3/4"X14	16	10	37	19	27
12611-12-12	G3/4"X14	20	12	36.5	19	27
12611-16-12	G1"X11	20	12	40.5	21	36
12611-16-16	G1"X11	25	16	41.5	21	36
12611-20-16	G1.1/4"X11	25	16	43.5	21	46
12611-20-20	G1.1/4"X11	32	20	44.5	21	46
12611-24-20	G1.1/2"X11	32	20	49	23	50
12611-24-24	G1.1/2"X11	40	24	46	23	50
12611-32-32	G2"X11	50	32	53.5	26	65

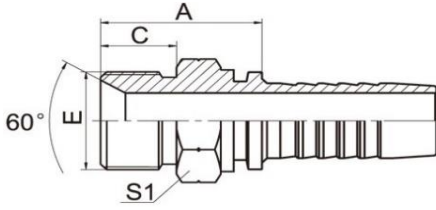
M BSP - 60° Cone or Bonded Seal
英管外螺纹60°内锥面或组合垫密封



12611A

PART NO 型号	THREAD	HOSE		DIMENSION		
	螺纹	软管		尺寸		
	E	DN	DASH	A	C	S1
12611A-04-04	G1/4x19	6	4	24.5	12	19
12611A-04-05	G1/4x19	8	5	24.5	12	19
12611A-06-05	G3/8x19	8	5	26	13.5	22
12611A-06-06	G3/8x19	10	6	28	13.5	22
12611A-06-08	G3/8x19	12	8	28.5	13.5	22
12611A-08-06	G1/2x14	10	6	33	16	27
12611A-08-08	G1/2x14	12	8	33	16	27
12611A-08-10	G1/2x14	16	10	34	16	27
12611A-10-08	G5/8x14	12	8	35	17.5	30
12611A-10-10	G5/8x14	16	10	35.5	17.5	30
12611A-12-08	G3/4x14	12	8	36.5	18.5	32
12611A-12-10	G3/4x14	16	10	37.5	18.5	32
12611A-12-12	G3/4x14	20	12	37.5	18.5	32
12611A-16-12	G1x11	20	12	42.5	20.5	41
12611A-16-16	G1x11	25	16	43.5	20.5	41
12611A-20-16	G1-1/4x11	25	16	45.5	20.5	50
12611A-20-20	G1-1/4x11	32	20	46.5	20.5	50
12611A-24-24	G1-1/2x11	40	24	49	23	55
12611A-32-32	G2x11	50	32	54.5	25.5	70

F BSP - 60° Cone Seal
英管内螺纹60°外锥面密封

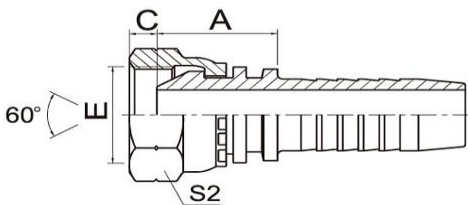

22611

PART NO 型号	THREAD	HOSE		DIMENSION		
	螺纹	软管		尺寸		
	E	DN	DASH	A	C	S1
22611-02-04	G1/8"X28	6	4	15	5.5	14
22611-04-03	G1/4"X19	5	3	17	5.5	19
22611-04-04	G1/4"X19	6	4	18	5.5	19
22611-04-05	G1/4"X19	8	5	18	5.5	19
22611-04-06	G1/4"X19	10	6	18	5.5	19
22611-06-04	G3/8"X19	6	4	19	6.3	22
22611-06-05	G3/8"X19	8	5	19	6.3	22
22611-06-06	G3/8"X19	10	6	19.5	6.3	22
22611-06-08	G3/8"X19	12	8	19.5	6.3	22
22611-08-08	G1/2"X14	12	8	21.5	7.5	27
22611-10-08	G5/8"X14	12	8	22	9.5	30
22611-10-10	G5/8"X14	16	10	23.5	9.5	30
22611-12-10	G3/4"X14	16	10	24	10.9	32
22611-12-12	G3/4"X14	20	12	24	10.9	32
22611-16-14	G1"X11	22	14	26	11.7	41
22611-16-16	G1"X11	25	16	27	11.7	41
22611-08-06T	G1/2"X14	10	6	21	7.5	27
22611-12-08T	G3/4"X14	12	8	22	10.9	32
22611-16-12T	G1"X11	20	12	24	11.7	41
22611-20-16T	G1.1/4"X11	25	16	27.5	11	50
22611-24-20T	G1.1/4"X11	32	20	32	13	55
22611-32-24T	G2"X11	40	24	30	16	70
22611-20-20W	G1.1/4"X11	32	20	30.5	11	50
22611-24-24W	G1.1/2"X11	40	24	32	13	55
22611-32-32W	G2"X11	50	32	31.9	16	70

F BSP - 60° Cone Seal - Double Hexagon
英管内螺纹60°外锥面双六角

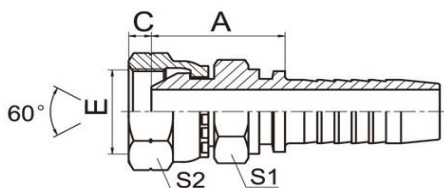

22611D

PART NO 型号	THREAD	HOSE		DIMENSION			
	螺纹	软管		尺寸			
	E	DN	DASH	A	C	S1	S2
22611D-04-04	G1/4"X19	6	4	23.5	5.5	19	19
22611D-06-06	G3/8"X19	10	6	26.5	6.3	22	22
22611D-08-08	G1/2"X14	12	8	31	7.5	27	27
22611D-10-08	G5/8"X14	12	8	32	9.5	30	30
22611D-12-08	G3/4"X14	12	8	33	10.9	32	32
22611D-12-12	G3/4"X14	20	12	34	10.9	32	32
22611D-16-16	G1"X11	25	16	35.5	11.7	41	41
22611D-20-20	G1.1/4"X11	32	20	43.5	11	50	50

F BSP - 60° Cone Seal - Small Double Hexagon
英管内螺纹60°外锥面双六角 - 小对边

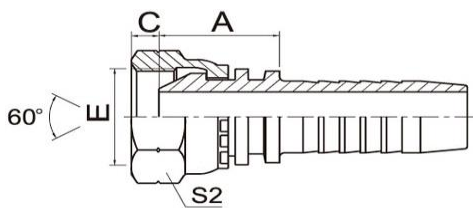

22611D-SM

PART NO 型号	THREAD	HOSE		DIMENSION			
	螺纹	软管		尺寸			
	E	DN	DASH	A	C	S1	S2
22611D-04-04SM	G1/4"X19	6	4	23	5.5	14	19
22611D-06-06SM	G3/8"X19	10	6	25	6.3	17	22
22611D-08-08SM	G1/2"X14	12	8	28.5	7.5	22	27
22611D-10-08SM	G5/8"X14	12	8	30	9.5	22	30
22611D-12-08SM	G3/4"X14	12	8	32.1	10.9	27	32
22611D-12-12SM	G3/4"X14	20	12	32.5	10.9	27	32
22611D-16-16SM	G1"X11	25	16	36.3	11.7	32	41
22611D-20-20SM	G1.1/4"X11	32	20	41.5	11	41	50

F BSP - 60° Cone Seal - 45°
45°英管内螺纹60°外锥面

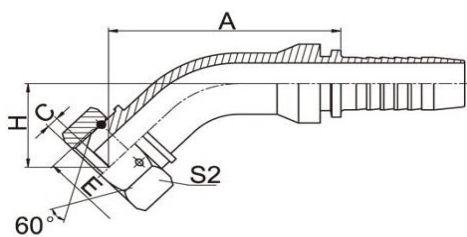

22641

PART NO 型号	THREAD	HOSE		DIMENSION			
	螺纹	软管		尺寸			
	E	DN	DASH	A	C	H	S2
22641-04-04	G1/4"X19	6	4	42.3	5.5	20.2	19
22641-06-04	G3/8"X19	6	4	43.2	6.3	21	22
22641-06-05	G3/8"X19	8	5	45.3	6.3	22	22
22641-06-06	G3/8"X19	10	6	46.9	6.3	22.6	22
22641-08-08	G1/2"X14	12	8	61.1	7.5	26.1	27
22641-10-08	G5/8"X14	12	8	61.4	9.5	26.5	30
22641-10-10	G5/8"X14	16	10	72.6	9.5	27.8	30
22641-12-10	G3/4"X14	16	10	73	10.9	28.2	32
22641-12-12	G3/4"X14	20	12	79.2	10.9	31.8	32
22641-16-16	G1"X11	25	16	88.4	11.7	34.2	41
22641-08-06T	G1/2"X14	10	6	48.1	7.5	23.9	27
22641-12-08T	G3/4"X14	12	8	61.8	10.9	26.9	32
22641-16-12T	G1"X11	20	12	80.8	11.7	33.4	41
22641-20-16T	G1.1/4"X11	25	16	85.3	11	31.1	50
22641-20-20W	G1.1/4"X11	32	20	98.8	11	38	50
22641-24-24W	G1.1/2"X11	40	24	117	13	45.5	55
22641-32-32W	G2"X11	50	32	136	16	52.7	70

F BSP - 60° Cone Seal - 90°
 90°英管内螺纹60°外锥面

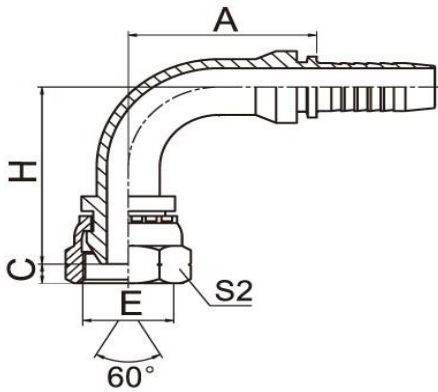

22691

PART NO 型号	THREAD	HOSE		DIMENSION			
	螺 纹	软管		尺 寸			
	E	DN	DASH	A	C	H	S2
22691-02-03	G1/8"X28	5	3	26.5	5.5	31.5	14
22691-02-04	G1/8"X28	6	4	30	5.5	34.5	14
22691-04-03	G1/4"X19	5	3	26.5	5.5	33.5	19
22691-04-04	G1/4"X19	6	4	30	5.5	36.5	19
22691-04-05	G1/4"X19	8	5	33	5.5	39.5	19
22691-04-06	G1/4"X19	10	6	30	5.5	36.5	19
22691-06-04	G3/8"X19	6	4	30	6.3	37.7	22
22691-06-05	G3/8"X19	8	5	33	6.3	40.7	22
22691-06-06	G3/8"X19	10	6	35.3	6.3	43	22
22691-08-08	G1/2"X14	12	8	41	7.5	51	27
22691-08-10	G1/2"X14	16	10	56.5	7.5	55.5	27
22691-10-08	G5/8"X14	12	8	41	9.5	51.5	30
22691-10-10	G5/8"X14	16	10	56.5	9.5	56	30
22691-12-10	G3/4"X14	16	10	56.5	10.9	56.6	32
22691-12-12	G3/4"X14	20	12	65.5	10.9	66	32
22691-16-14	G1"X11	22	14	71.2	11.7	69.3	41
22691-16-16	G1"X11	25	16	76.7	11.7	73.8	41
22691-08-06T	G1/2"X14	10	6	35.3	7	43.3	27
22691-12-08T	G3/4"X14	12	8	41	10.9	52.1	32
22691-16-12T	G1"X11	20	12	65.5	11.7	68.3	41
22691-20-16T	G1.1/4"X11	25	16	78	11	69.5	50
22691-20-20W	G1.1/4"X11	32	20	91.5	11	84.3	50
22691-24-24W	G1.1/2"X11	40	24	109	13	103	55
22691-32-32W	G2"X11	50	32	132	16	123	70

F BSP - 60° Cone Seal - 90°
Compact
 90°英管内螺纹60°外锥面

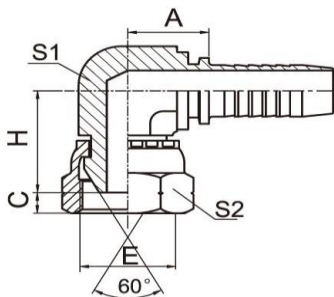

22691K

PART NO 型号	THREAD	HOSE		DIMENSION				
	螺 纹	软管		尺 寸				
	E	DN	DASH	A	C	H	S1	S2
22691K-04-04	G1/4"X19	6	4	17.5	5.5	18.5	11	19
22691K-06-04	G3/8"X19	6	4	20	6.3	23	16	22
22691K-06-05	G3/8"X19	8	5	20	6.3	23	16	22
22691K-06-06	G3/8"X19	10	6	20	6.3	24	16	22
22691K-08-06	G1/2"X14	10	6	23	7.5	26.5	19	27
22691K-08-08	G1/2"X14	12	8	23.5	7.5	28.5	19	27
22691K-10-10	G5/8"X14	16	10	25	9.5	29.2	22	30
22691K-12-12	G3/4"X14	20	12	27.5	10.9	33	27	32
22691K-16-16	G1"X11	25	16	32.5	11.7	38.1	33	41

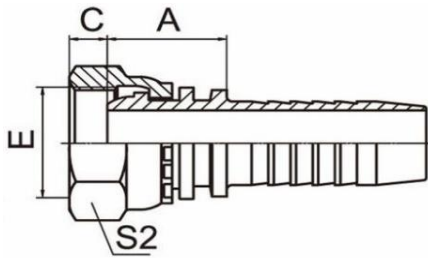
F BSP - Multi Seal
英管内螺纹球面

22111

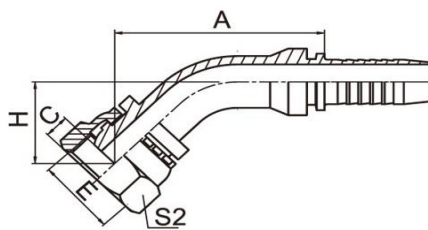
PART NO 型号	THREAD	HOSE		DIMENSION		
	螺 纹	软管		尺 寸		
	E	DN	DASH	A	C	S1
22111-02-04	G1/8"X28	6	4	19	2	14
22111-04-03	G1/4"X19	5	3	19	4	19
22111-04-04	G1/4"X19	6	4	19.5	4	19
22111-06-05	G3/8"X19	8	5	20	5	22
22111-06-06	G3/8"X19	10	6	20.5	5	22
22111-06-08	G3/8"X19	12	8	21	5	22
22111-08-08	G1/2"X14	12	8	23	6	27
22111-08-10	G1/2"X14	16	10	24	6	27
22111-10-10	G5/8"X14	16	10	25	8	30
22111-10-12	G5/8"X14	20	12	25	8	30
22111-12-10	G3/4"X14	16	10	26	9.5	32
22111-12-12	G3/4"X14	20	12	26	9.5	32
22111-16-14	G1"X11	22	14	26.5	11	41
22111-16-16	G1"X11	25	16	28	11	41
22111-08-06T	G1/2"X14	10	6	22.5	6	27
22111-12-08T	G3/4"X14	12	8	25	9.5	32
22111-16-12T	G1"X11	20	12	26.5	11	41
22111-20-16T	G1.1/4"X11	25	16	27.5	11	50
22111-20-20W	G1.1/4"X11	32	20	31.5	10	50
22111-24-24W	G1.1/2"X11	40	24	37	11.5	55
22111-32-32W	G2"X11	50	32	34	15	70

F BSP - Multi Seal - 45°
45° 英管内螺纹球面

22141

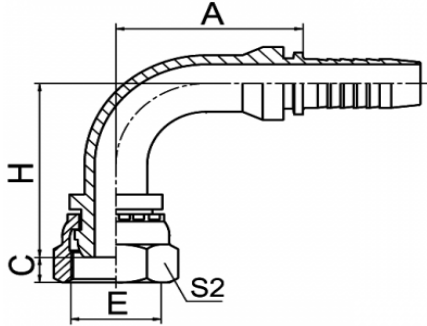
PART NO 型号	THREAD	HOSE		DIMENSION			
	螺 纹	软管		尺 寸			
	E	DN	DASH	A	C	H	S2
22141-02-04	G1/8"X28	6	4	43.7	2	21.6	14
22141-04-04	G1/4"X19	6	4	43.7	4	21.6	19
22141-06-05	G3/8"X19	8	5	46.2	5	22.9	22
22141-06-06	G3/8"X19	10	6	48.1	5	23.9	22
22141-06-08	G3/8"X19	12	8	60.4	5	25.4	22
22141-08-08	G1/2"X14	12	8	61.8	6	26.8	27
22141-08-10	G1/2"X14	16	10	73	6	29	27
22141-10-10	G5/8"X14	16	10	73.7	8	28.9	30
22141-10-12	G5/8"X14	20	12	79.8	8	32.5	30
22141-12-10	G3/4"X14	16	10	70.4	9.5	29.6	32
22141-12-12	G3/4"X14	20	12	80.6	9.5	33.2	32
22141-16-12	G1"X11	20	12	81.6	11	33.5	41
22141-16-14	G1"X11	22	14	83.3	11	33	41
22141-16-16	G1"X11	25	16	89.2	11	35	41
22141-20-20W	G1.1/4"X11	32	20	103	10	41.2	50
22141-24-24W	G1.1/2"X11	40	24	120	11.5	49	55
22141-32-32W	G2"X11	50	32	137	15	53	70

F BSP - Multi Seal - 90°
90° 英管内螺纹球面



22191

PART NO 型号	THREAD	HOSE		DIMENSION			
	螺纹	软管		尺寸			
	E	DN	DASH	A	C	H	S2
22191-02-04	G1/8"X28	6	4	30	2	38.5	14
22191-04-03	G1/4"X19	5	3	27	4	35	19
22191-04-04	G1/4"X19	6	4	30	4	38.5	19
22191-04-05	G1/4"X19	8	5	33	4	41.5	19
22191-06-05	G3/8"X19	8	5	33	5	42	22
22191-06-06	G3/8"X19	10	6	35.3	5	44.8	22
22191-06-08	G3/8"X19	12	8	41	5	50	22
22191-08-08	G1/2"X14	12	8	41	6	52	27
22191-08-10	G1/2"X14	16	10	56.5	6	58	27
22191-10-10	G5/8"X14	16	10	56.5	8	57.5	30
22191-10-12	G5/8"X14	20	12	65.4	8	67	30
22191-12-10	G3/4"X14	16	10	56.5	9.5	58.5	32
22191-12-12	G3/4"X14	20	12	65.5	9.5	68	32
22191-16-14	G1"X11	22	14	71.2	11	69.5	41
22191-16-16	G1"X11	25	16	76.7	11	75	41
22191-08-06T	G1/2"X14	10	6	35.3	6	46.8	27
22191-02-08T	G3/4"X14	12	8	41	9.5	52	32
22191-16-12T	G1"X11	20	12	66.2	11	68.5	41
22191-20-16T	G1.1/4"X11	25	16	76.7	10	78	50
22191-20-20	G1.1/4"X11	32	20	92.3	10	85.3	50
22191-24-24	G1.1/2"X11	40	24	109.4	11.5	108	55
22191-32-32	G2"X11	50	32	133.1	15	123.8	70

BSPT SERIES 英锥管外螺纹系列

M BSPT
英锥管外螺纹

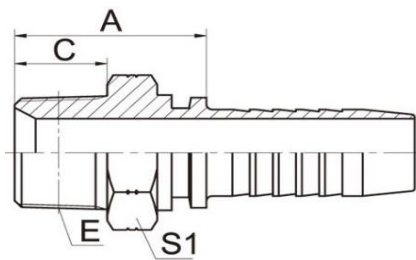

13011-SP

PART NO 型号	THREAD	HOSE		DIMENSION		
	螺纹	软管		尺寸		
	E	DN	DASH	A	C	H
13011-02-04SP	R1/8x28	6	4	22.5	10	12
13011-04-04SP	R1/4x19	6	4	27	14.5	14
13011-04-05SP	R1/4x19	8	5	27	14.5	14
13011-04-06SP	R1/4x19	10	6	27	14.5	17
13011-06-04SP	R3/8x19	6	4	27.5	15	17
13011-06-05SP	R3/8x19	8	5	27.5	15	17
13011-06-06SP	R3/8x19	10	6	27.5	15	17
13011-06-08SP	R3/8x19	12	8	28	15	19
13011-08-06SP	R1/2x14	10	6	34.5	20	22
13011-08-08SP	R1/2x14	12	8	35	20	22
13011-08-10SP	R1/2x14	16	10	35.5	20	22
13011-08-12SP	R1/2x14	20	12	38	20	27
13011-12-08SP	R3/4x14	12	8	37	20	27
13011-12-10SP	R3/4x14	16	10	38	20	27
13011-12-12SP	R3/4x14	20	12	38.5	20	27
13011-12-16SP	R3/4x14	25	16	40.5	20	32
13011-16-12SP	R1x11	20	12	43.5	25.5	36
13011-16-16SP	R1x11	25	16	45	25.5	36
13011-20-20SP	R1-1/4x11	32	20	49.5	26.5	46
13011-24-24SP	R1-1/2x11	40	24	52.5	26.5	50
13011-32-24SP	R2x11	40	24	57	30	65
13011-32-32SP	R2x11	50	32	57	30	65

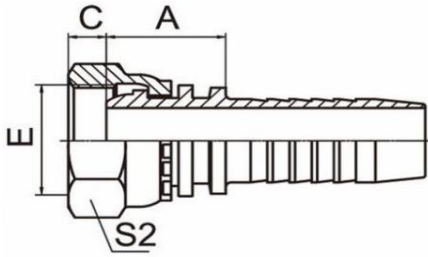
F BSP - Flat Seal
英管内螺纹平面

22211

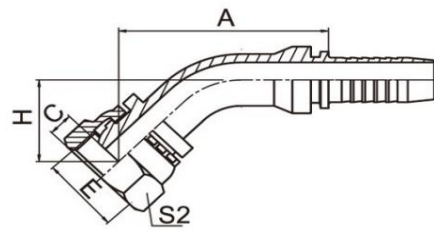
PART NO 型号	THREAD	HOSE		DIMENSION		
	螺 纹	软管		尺 寸		
	E	DN	DASH	A	C	S1
22211-04-04	G1/4x19	6	4	15.5	8	19
22211-06-05	G3/8x19	8	5	17	9	22
22211-06-06	G3/8x19	10	6	16.5	9	22
22211-08-08	G1/2x14	12	8	18.5	10.5	27
22211-10-10	G5/8x14	16	10	21	12	30
22211-12-12	G3/4x14	20	12	21.5	13.5	32
22211-16-16	G1x11	25	16	23	15.5	41
22211-20-20	G1-1/4x11	32	20	26	15.5	50
22211-24-24	G1-1/2x11	40	24	27.5	17.5	55
22211-32-32	G2x11	50	32	30.5	23	70

F BSP - Flat Seal - 45°
45° 英管内螺纹平面

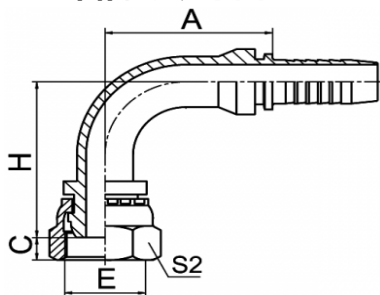
22241

PART NO 型号	THREAD	HOSE		DIMENSION			
	螺 纹	软管		尺 寸			
	E	DN	DASH	A	C	H	S2
22241-04-04	G1/4x19	6	4	40.9	8	18.8	19
22241-06-06	G3/8x19	10	6	45.3	9	21	22
22241-08-08	G1/2x14	12	8	58.9	10.5	24	27
22241-12-12	G3/4x14	20	12	77.4	13.5	30	32
22241-14-14	G1x11	25	16	82.7	15.5	31.5	41
22241-20-20	G1-1/4x11	32	20	97.3	15.5	36.6	50

F BSP - Flat Seal - 90°
90° 英管内螺纹平面

22291

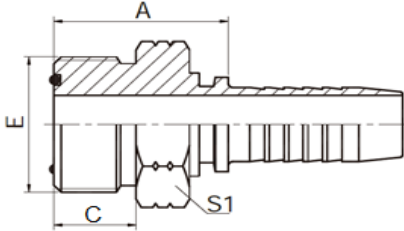
PART NO 型号	THREAD	HOSE		DIMENSION			
	螺 纹	软管		尺 寸			
	E	DN	DASH	A	C	H	S2
22291-04-04	G1/4x19	6	4	30	8	34.5	19
22291-06-06	G3/8x19	10	6	35.3	9	41.3	22
22291-08-08	G1/2x14	12	8	41	10.5	48	27
22291-12-12	G3/4x14	20	12	65.5	13.5	63.5	32
22291-16-16	G1x11	25	16	76.7	15.5	70	41
22291-20-20	G1-1/4x11	32	20	91.5	15.5	82.5	50
22291-24-24	G1-1/2x11	40	24	109	17.5	98.5	55

M ORFS - Flat Seal 美制ORFS外螺纹平面O形圈密封



14211

PART NO 型号	THREAD	HOSE		O-RING	DIMENSION		
	螺纹	软管		O型圈	尺寸		
	E	DN	DASH	O	A	C	S1
14211-04-04	9/16"X18	6	4	O011	22	9.8	17
14211-06-04	11/16"X16	6	4	O012	24	11	19
14211-06-06	11/16"X16	10	6	O012	24	11	19
14211-08-06	13/16"X16	10	6	O014	28	13	22
14211-08-08	13/16"X16	12	8	O014	29	13	22
14211-08-10	13/16"X16	16	10	O014	29	13	22
14211-10-08	1"X14	12	8	O016	33	16	27
14211-10-10	1"X14	16	10	O016	34	16	27
14211-12-08	1.3/16"X12	12	8	O018	36	17	32
14211-12-10	1.3/16"X12	16	10	O018	37	17	32
14211-12-12	1.3/16"X12	20	12	O018	37	17	32
14211-16-12	1.7/16"X12	20	12	O021	37	18	38
14211-16-16	1.7/16"X12	25	16	O021	39	18	38
14211-20-20	1.11/16"X12	32	20	O025	42	18	46
14211-24-24	2"X12	40	24	O029	44	18	55

F ORFS - Flat Seal 美制ORFS内螺纹平面O形圈密封

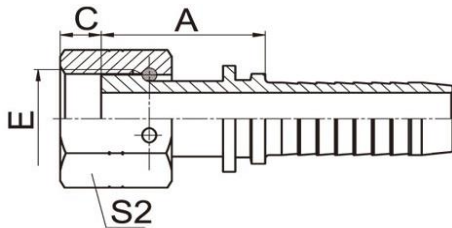

24211/24211-T

PART NO 型号	THREAD	HOSE		DIMENSION		
	螺纹	软管		尺寸		
	E	DN	DASH	A	C	S2
24211-04-04	9/16"X18	6	4	22.5	8.5	19
24211-04-05	9/16"X18	8	5	22.5	8.5	19
24211-04-06	9/16"X16	10	6	22.5	8.5	19
24211-06-06	11/16"X16	10	6	25.5	10	22
24211-06-08	11/16"X16	12	8	26	10	22
24211-08-08	13/16"X16	12	8	28	11	27
24211-08-10	13/16"X16	16	10	29	11	27
21211-10-10	1"X14	16	10	33.5	14	30
24211-10-12	1"X14	20	12	33.5	14	30
24211-12-12	1.3/16"X12	20	12	35	15	36
24211-12-16	1.3/16"X12	25	16	36	15	36
24211-16-20	1.7/16"X12	32	20	39.5	15	41
24211-06-04T	11/16"X16	6	4	23.5	10	22
24211-06-05T	11/16"X16	8	5	23.5	10	22
24211-08-05T	13/16"X16	8	5	25	11	27
24211-08-06T	13/16"X16	10	6	25	11	27
24211-10-08T	1"X14	12	8	29.5	14	30
24211-12-08T	1.3/16"X12	12	8	30.5	15	36
24211-12-10T	1.3/16"X12	16	10	31.5	15	36
24211-16-12T	1.7/16"X12	20	12	35	15	41
24211-16-14T	1.7/16"X12	22	14	34	15	41
24211-16-16T	1.7/16"X12	25	16	35	15	41
24211-20-16T	1.11/16"X12	25	16	35	15	50
24211-24-20T	2"X12	32	20	36	15	60
24211-24-24T	2"X12	40	24	36	15	60
24211-20-20W	1.11/16"X12	32	20	39.5	15	50
24211-20-24W	1.11/16"X12	40	24	39.5	15	50

F ORFS - Flat Seal - 45°
45°美制ORFS内螺纹平面O形圈密封

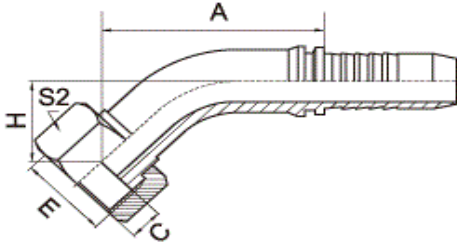

24241/24241-T

PART NO 型号	THREAD	HOSE		DIMENSION			
	螺 纹	软管		尺 寸			
	E	DN	DASH	A	H	C	S2
24241-04-04	9/16"X18	6	4	45.5	23	8.5	19
24241-04-05	9/16"X18	8	5	47.6	24	8.5	19
24241-04-06	9/16"X18	10	6	49.2	25	8.5	19
24241-06-06	11/16"X16	10	6	51.7	27	10	22
24241-06-08	11/16"X16	12	8	63.9	29	10	22
24241-08-08	13/16"X16	12	8	65.3	30	11	27
24241-08-10	13/16"X16	16	10	76.5	32	11	27
24241-10-10	1"X14	16	10	79.7	35	14	30
24241-10-12	1"X14	20	12	86.5	38	14	30
24241-12-12	1.3/16"X12	20	12	87.6	40	15	36
24241-12-16	1.3/16"X12	25	16	95.3	41	15	36
24241-16-20	1.7/16"X12	32	20	103.8	46	15	41
24241-06-04T	11/16"X16	6	4	39.5	17	10	22
24241-06-05T	11/16"X16	8	5	42.3	19	10	22
24241-08-06T	13/16"X16	10	6	44.6	20	11	27
24241-10-08T	1"X14	12	8	58.2	23	14	30
24241-12-08T	1.3/16"X12	12	8	58.2	23	15	36
24241-12-10T	1.3/16"X12	16	10	69.4	25	15	36
24241-16-12T	1.7/16"X12	20	12	74	30	15	41
24241-16-14T	1.7/16"X12	22	14	78.7	29	15	41
24241-16-16T	1.7/16"X12	25	16	84.1	30	15	41
24241-20-16T	1.11/16"X12	25	16	80.9	33	15	50
24241-24-20T	2"X12	32	20	94.5	34	15	60
24241-24-24T	2"X12	40	24	108.5	38	15	60
24241-20-20W	1.11/16"X12	32	20	111.2	49	15	50
24241-20-24W	1.11/16"X12	40	24	123.6	53	15	50

F ORFS - Flat Seal - 90°
90°美制ORFS内螺纹平面O形圈密封

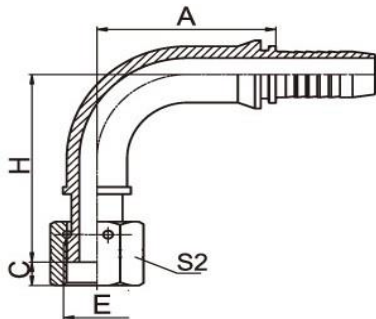

24291/24291-T

PART NO 型号	THREAD	HOSE		DIMENSION			
	螺 纹	软管		尺 寸			
	E	DN	DASH	A	H	C	S2
24291-04-04	9/16"X18	6	4	30	41	8.5	19
24291-04-05	9/16"X18	8	5	33	44	8.5	19
24291-04-06	9/16"X18	10	6	35.3	46	8.5	19
24291-06-06	11/16"X16	10	6	35.3	50	10	22
24291-06-08	11/16"X16	12	8	41	55	10	22
24291-08-08	13/16"X16	12	8	41	57	11	27
24291-08-10	13/16"X16	16	10	56.5	62	11	27
24291-10-10	1"X14	16	10	56.5	66	14	30
24291-10-12	1"X14	20	12	65.5	76	14	30
24291-12-12	1.3/16"X12	20	12	65.5	77	15	36
24291-12-16	1.3/16"X12	25	16	76.7	84	15	36
24291-16-20	1.7/16"X12	32	20	91.5	96	15	41
24291-06-05T	11/16"X16	8	5	33	38	10	22
24291-08-06T	13/16"X16	10	6	35.3	40	11	27
24291-10-08T	1"X14	12	8	41	46	14	30
24291-12-10T	1.3/16"X12	16	10	56.5	52	15	36
24291-16-12T	1.7/16"X12	20	12	65.5	63	15	41
24291-16-14T	1.7/16"X12	22	14	71.2	63	15	41
24291-16-16T	1.7/16"X12	25	16	76.9	68	15	41

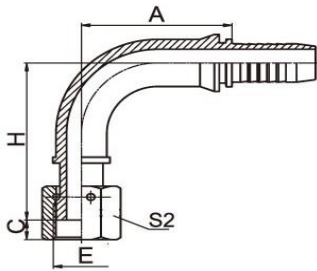
F ORFS - Flat Seal - 90°
 90°美制ORFS内螺纹平面O形圈密封

24291-T

PART NO 型号	THREAD	HOSE		DIMENSION			
	螺 纹	软管		尺 寸			
	E	DN	DASH	A	H	C	S2
24291-20-16T	1.11/16"X12	25	16	76.7	67.5	15	50
24291-24-20T	2"X12	32	20	91.5	78.5	14.8	60
24291-24-24T	2"X12	40	24	109	92	14.8	60
24291-20-20W	1.11/16"X12	32	20	93	100	15	50
24291-20-24W	1.11/16"X12	40	24	109	114	15	50

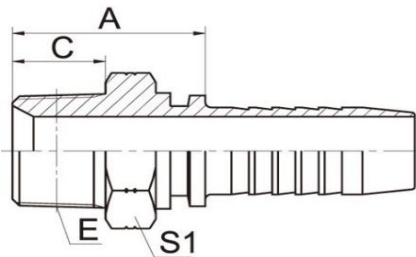
MALE NPT SERIES 布锥管外螺纹系列

M NPT
 布锥管外螺纹

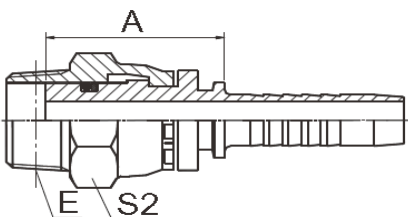
15611

PART NO 型号	THREAD	HOSE		DIMENSION		
	螺 纹	软管		尺 寸		
	E	DN	DASH	A	C	S2
15611-02-03	Z1/8"X27	5	3	22.5	10.5	12
15611-02-04	Z1/8"X27	6	4	22.5	10.5	12
15611-04-03	Z1/4"X18	5	3	27.5	15	17
15611-04-04	Z1/4"X18	6	4	28	15	17
15611-04-05	Z1/4"X18	8	5	28	15	17
15611-04-06	Z1/4"X18	10	6	27	15	17
15611-06-04	Z3/8"X18	6	4	28	16	19
15611-06-05	Z3/8"X18	8	5	28	16	19
15611-06-06	Z3/8"X18	10	6	30	16	19
15611-06-08	Z3/8"X18	12	8	30.5	16	19
15611-08-06	Z1/2"X14	10	6	34.5	19.5	22
15611-08-08	Z1/2"X14	12	8	34.5	19.5	22
15611-08-10	Z1/2"X14	16	10	36	19.5	22
15611-12-08	Z3/8"X14	12	8	37.5	19.5	27
15611-12-10	Z3/4"X14	16	10	38	19.5	27
15611-12-12	Z3/4"X14	20	12	38.5	19.5	27
15611-12-16	Z3/4"X14	25	16	39.5	19.5	32
15611-16-10	Z1"X11.5	16	10	45	25.5	36
15611-16-12	Z1"X11.5	20	12	45	25.5	36
15611-16-16	Z1"X11.5	25	16	44.5	25.5	36
15611-20-16	Z1.1/4"X11.5	25	16	49.5	26.5	46
15611-20-20	Z1.1/4"X11.5	32	20	49	26.5	46
15611-24-24	Z1.1/2"X11.5	40	24	51	27.5	50
15611-32-32	Z2"X11.5	50	32	55	27.5	65

M NPT - SWIVEL
 布锥管旋转外螺纹

15611-SW

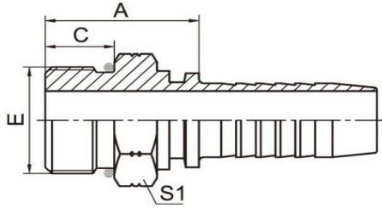
PART NO 型号	THREAD	HOSE		DIMENSION	
	螺 纹	软管		尺 寸	
	E	DN	DASH	A	S2
15611SW-04-04	Z1/4"X18	6	4	56	19
15611SW-06-06	Z3/8"X18	10	6	60	22
15611SW-08-08	Z1/2"X14	12	8	66	27
15611SW-12-12	Z3/4"X14	20	12	68.4	32

M SAE - O-Ring Seal 美制SAE外螺纹带O形圈



16011

PART NO 型号	THREAD	HOSE		O-RING	DIMENSION		
	螺纹	软管		O型圈	尺寸		
	E	DN	DASH	O	A	C	S1
16011-04-04	7/16"X20	6	4	O904	22	9.1	14
16011-05-06	1/2"X20	6	4	O905	22	9.1	17
16011-06-05	9/16"X18	8	5	O906	23	9.9	17
16011-06-06	9/16"X18	10	6	O906	23	9.9	17
16011-08-06	3/4"X16	10	6	O908	25	11	22
16011-08-08	3/4"X16	12	8	O908	25	11	22
16011-10-08	7/8"X14	12	8	O910	30	13	27
16011-10-10	7/8"X14	16	10	O910	31	13	27
16011-12-10	1.1/16"X12	16	10	O912	34	15	32
16011-12-12	1.1/16"X12	20	12	O912	34	15	32
16011-16-16	1.5/16"X12	25	16	O916	36	15	38

JIC 74° CONE SEAL SERIES 美制JIC内螺纹74° 锥面密封系列

M JIC - 74° Cone Seal 美制JIC外螺纹74° 外锥面

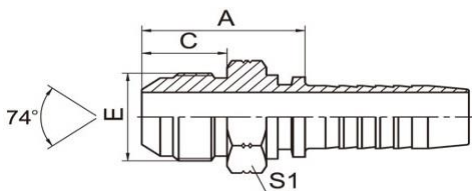

16711

PART NO 型号	THREAD	HOSE		DIMENSION		
	螺纹	软管		尺寸		
	E	DN	DASH	A	C	S1
16711-04-03	7/16"X20	5	3	26	14	12
16711-04-04	7/16"X20	6	4	26.5	14	12
16711-05-04	1/2"X20	6	4	26.5	14	14
16711-05-05	1/2"X20	8	5	26.5	14	14
16711-05-06	1/2"X20	10	6	26.5	14	17
16711-06-04	9/16"X18	6	4	26.5	14	17
16711-06-05	9/16"X18	8	5	26.5	14	17
16711-06-06	9/16"X18	10	6	26.5	14	17
16711-08-06	3/4"X16	10	6	31.5	17	22
16711-08-08	3/4"X16	12	8	32	17	22
16711-10-06	7/8"X14	10	6	32	19	24
16711-10-08	7/8"X14	12	8	34.3	19	24
16711-10-10	7/8"X14	16	10	35.5	19	24
16711-12-08	1.1/16"X12	12	8	39	22	27
16711-12-10	1.1/16"X12	16	10	40	22	27
16711-12-12	1.1/16"X12	20	12	40	22	27
16711-12-16	1.1/16"X12	25	16	41	22	30
16711-14-10	1.3/16"X12	16	10	41.5	23	32
16711-14-12	1.3/16"X12	20	12	40.6	23	32
16711-16-12	1.5/16"X12	20	12	42.5	23	36
16711-16-16	1.5/16"X12	25	16	43.5	23	36
16711-20-16	1.5/8"X12	25	16	46.5	24	46
16711-20-20	1.5/8"X12	32	20	47.5	24	46
16711-24-20	1.7/8"X12	32	20	53	28	50
16711-24-24	1.7/8"X12	40	24	53	28	50
16711-32-32	2.1/2"X12	50	32	62	34	65

M JIC - 74° Cone Seal
美制JIC外螺纹74° 外锥面

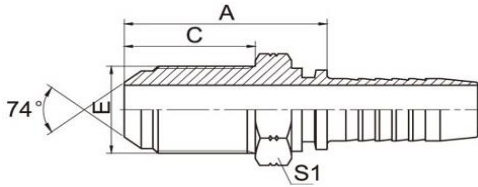

16711L

PART NO 型号	THREAD	HOSE		DIMENSION		
	螺 纹	软管		尺 寸		
	E	DN	DASH	A	C	S1
16711L-04-04	7/16x20	6	4	45	32.5	17
16711L-05-04	1/2x20	6	4	43	30.5	19
16711L-05-05	1/2x20	8	5	43	30.5	19
16711L-06-04	9/16x18	6	4	47	32.5	22
16711L-06-05	9/16x18	8	5	47	32.5	22
16711L-06-06	9/16x18	10	6	47	32.5	22
16711L-08-06	3/4x16	10	6	51	36.5	24
16711L-08-08	3/4x16	12	8	51.5	36.5	24
16711L-10-06	7/8x14	10	6	56.5	40	30
16711L-10-08	7/8x14	12	8	57	40	30
16711L-10-10	7/8x14	16	10	58	40	30
16711L-12-08	1-1/16x12	12	8	63.5	44.5	36
16711L-12-10	1-1/16x12	16	10	64	44.5	36
16711L-12-12	1-1/16x12	20	12	64.5	44.5	36
16711L-16-12	1-5/16x12	20	12	66	44.5	41
16711L-16-16	1-5/16x12	25	16	67	44.5	41
16711L-20-16	1-5/8x12	25	16	70.5	45.7	50
16711L-20-20	1-5/8x12	32	20	71.2	45.7	50
16711L-24-20	1-7/8x12	32	20	71.5	46	55
16711L-24-24	1-7/8x12	40	24	71.5	46	55

F JIC - 74° Cone Seal
美制JIC内螺纹74° 内锥面

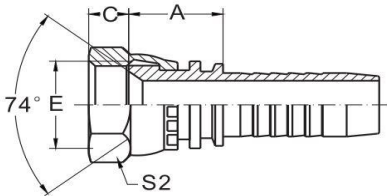

26711

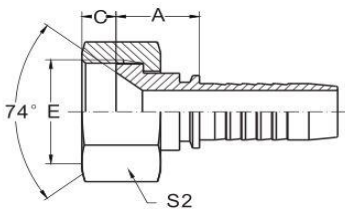

26711-T

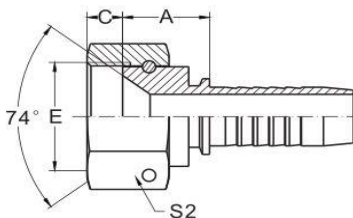

26711-W

PART NO 型号	THREAD	HOSE		DIMENSION		
	螺 纹	软管		尺 寸		
	E	DN	DASH	A	C	S1
26711-04-03	7/16"X20	5	3	14.5	9	15
26711-04-04	7/16"X20	6	4	15	9	15
26711-05-04	1/2"X20	6	4	15.5	9.5	17
26711-05-05	1/2"X20	8	5	15.5	9.5	17
26711-05-06	1/2"X20	10	6	15.5	9.5	17
26711-06-04	9/16"X18	6	4	15.5	10.5	19
26711-06-05	9/16"X18	8	5	15.5	10.5	19
26711-06-06	9/16"X18	10	6	15.5	10.5	19
26711-06-08	9/16"X18	12	8	16	10.5	19
26711-08-06	3/4"X16	10	6	17.5	11	24
26711-08-08	3/4"X16	12	8	18	11	24
26711-08-10	3/4"X16	16	10	19.5	11	24
26711-10-08	7/8"X14	12	8	18.5	13	27
26711-10-10	7/8"X14	16	10	20	13	27
26711-10-12	7/8"X14	20	12	20	13	27
26711-12-10	1.1/16"X12	16	10	21.5	15	32
26711-12-12	1.1/16"X12	20	12	21.5	15	32
26711-12-16	1.1/16"X12	25	16	23	15	32
26711-14-12	1.1/16"X12	20	12	21.5	15	36
26711-16-16	1.5/16"X12	25	16	23	16	41
26711-16-20	1.5/16"X12	32	20	24	16	41
26711-12-08T	1.1/16"X12	12	8	19	15	32
26711-16-12T	1.5/16"X12	20	12	18.5	16	41
26711-20-16T	1.5/8"X12	25	16	23	17	50
26711-20-20W	1.5/8"X12	32	20	26	17	50

M JIC - 74° Cone Seal
美制JIC外螺纹74° 外锥面

26711

PART NO 型号	THREAD	HOSE		DIMENSION		
	螺纹	软管		尺寸		
	E	DN	DASH	A	C	S1
26711-24-20W	1.7/8"X12	32	20	26.5	20	55
26711-24-24W	1.7/8"X12	40	24	26.5	20	55
26711-32-24T	2.1/2"X12	40	24	27	23.5	75
26711-32-32T	2.1/2"X12	50	32	27	23.5	75

F JIC - 74° Cone Seal - Double Hexagon
美制JIC内螺纹74° 内锥面双六角

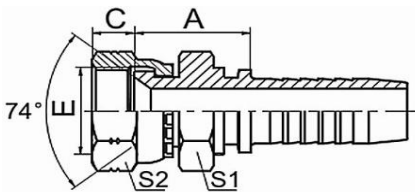

26711D

PART NO 型号	THREAD	HOSE		DIMENSION			
	螺纹	软管		尺寸			
	E	DN	DASH	A	C	S1	S2
26711D-04-04	7/16"X20	6	4	20	9	15	15
26711D-05-04	1/2"X20	6	4	20.5	9.5	17	17
26711D-06-04	9/16"X18	6	4	21	10.5	19	19
26711D-06-06	9/16"X18	10	6	21	10.5	19	19
26711D-08-06	3/4"X16	10	6	25	11	24	24
26711D-08-08	3/4"X16	12	8	24.5	11	24	24
26711D-08-10	3/4"X16	16	10	25.5	11	24	24
26711D-10-08	7/8"X14	12	8	28	13	27	27
26711D-10-10	7/8"X14	16	10	29	13	27	27
26711D-12-12	1.1/16"X12	20	12	31.5	15	32	32
26711D-16-12	1.5/16"X12	20	12	33.5	16	41	41
26711D-16-16	1.5/16"X12	25	16	34.5	16	41	41
26711D-16-20	1.5/16"X12	32	20	36.5	16	41	41
26711D-20-20	1.7/16"X12	32	20	39	17	50	50

F JIC - 74° Cone Seal - Small Double Hexagon
美制JIC内螺纹74° 内锥面双六角 - 小对边

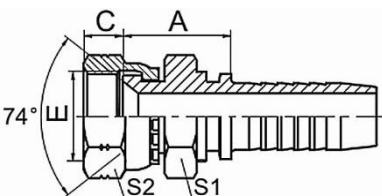

26711D-SM

PART NO 型号	THREAD	HOSE		DIMENSION			
	螺纹	软管		尺寸			
	E	DN	DASH	A	C	S1	S2
26711D-04-04SM	7/16"X20	6	4	20	9	12	15
26711D-05-04SM	1/2"X20	6	4	20.5	9.5	12	17
26711D-06-04SM	9/16"X18	6	4	21	10.5	14	19
26711D-06-06SM	9/16"X18	10	6	21	10.5	17	19
26711D-08-06SM	3/4"X16	10	6	23	11	19	24
26711D-08-08SM	3/4"X16	12	8	24.5	11	22	24
26711D-08-10SM	3/4"X16	16	10	25.5	11	22	24
26711D-10-08SM	7/8"X14	12	8	24	13	22	27
26711D-10-10SM	7/8"X14	16	10	27	13	22	27
26711D-12-12SM	1.1/16"X12	20	12	31.5	15	27	32
26711D-16-12SM	1.5/16"X12	20	12	31.5	16	32	41
26711D-16-16SM	1.5/16"X12	25	16	32.5	16	32	41
26711D-20-20SM	1.7/16"X12	32	20	37	17	41	50

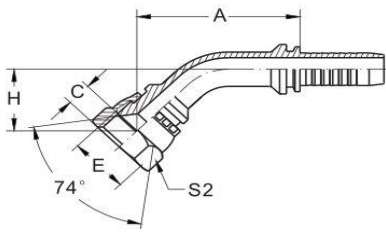
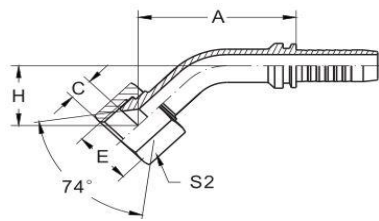
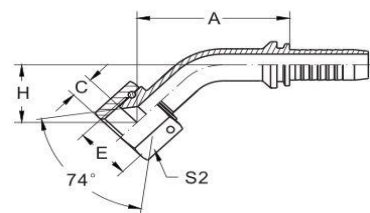
F JIC - 74° Cone Seal - 45°
45°美制JIC内螺纹74° 内锥面

26741

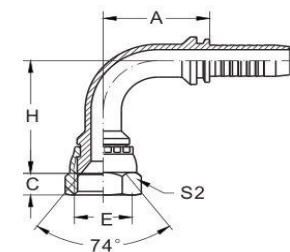
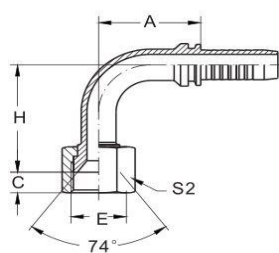
26741-T

26741-W

PART NO 型号	THREAD	HOSE		DIMENSION			
	螺 纹	软管		尺 寸			
	E	DN	DASH	A	C	H	S2
26741-04-03	7/16"X20	5	3	37.6	9	17.2	15
26741-04-04	7/16"X20	6	4	40.2	9	18.1	15
26741-05-04	1/2"X20	6	4	40.5	9.5	18.5	17
26741-05-05	1/2"X20	8	5	42.7	9.5	19.3	17
26741-05-06	1/2"X20	10	6	44.6	9.5	20.3	17
26741-06-04	9/16"X18	6	4	40.5	10.5	18.5	19
26741-06-05	9/16"X18	8	5	42.7	10.5	19.3	19
26741-06-06	9/16"X18	10	6	44.3	10.5	20	19
26741-06-08	9/16"X18	12	8	56.8	10.5	21.9	19
26741-08-06	3/4"X16	10	6	45.7	11	21.4	24
26741-08-08	3/4"X16	12	8	58.6	11	23.5	24
26741-10-08	7/8"X14	12	8	58.9	13	24	27
26741-10-10	7/8"X14	16	10	70.1	13	25.3	27
26741-10-12	7/8"X14	20	12	77	13	28.9	27
26741-12-08	1.1/16"X12	12	8	60	15	25	32
26741-12-10	1.1/16"X12	16	10	71.2	15	26.4	32
26741-12-12	1.1/16"X12	20	12	77.4	15	30	32
26741-12-16	1.1/16"X12	25	16	85.3	15	31	32
26741-14-12	1.3/16"X12	20	12	77.4	15	30	36
26741-16-12	1.5/16"X12	20	12	77.4	16	30	41
26741-16-16	1.5/16"X12	25	16	85.7	16	31.5	41
26741-16-20	1.5/16"X12	32	20	96.3	16	35.5	41
26741-20-20W	1.5/8"X12	32	20	96.6	17	35.9	50
26741-24-20W	1.7/8"X12	32	20	101	20	40.1	55
26741-24-24W	1.7/8"X12	40	24	115	20	44.1	55
26741-32-32W	2.1/2"X12	50	32	136	23.5	51.6	75

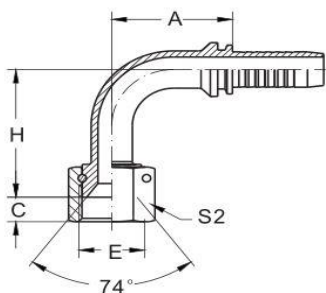
F JIC - 74° Cone Seal - 90°
90°美制JIC内螺纹74° 内锥面

26791

26791-T

PART NO 型号	THREAD	HOSE		DIMENSION			
	螺 纹	软管		尺 寸			
	E	DN	DASH	A	C	H	S2
26791-04-03	7/16"X20	5	3	26.5	9	30.5	15
26791-04-04	7/16"X20	6	4	30	9	33.5	15
26791-05-04	1/2"X20	6	4	30	9.5	34	17
26791-05-05	1/2"X20	8	5	33	9.5	37	17
26791-05-06	1/2"X20	10	6	35.3	9.5	39.3	17
26791-06-04	9/16"X18	6	4	30	10.5	34	19
26791-06-05	9/16"X18	8	5	33	10.5	37	19
26791-06-06	9/16"X18	10	6	35.3	10.5	39.3	19
26791-06-08	9/16"X18	12	8	41	10.5	45.5	19
26791-08-06	3/4"X16	10	6	35.3	11	41.3	24
26791-08-08	3/4"X16	12	8	41	11	47	24
26791-08-10	3/4"X16	16	10	56.5	11	51.5	24
26791-10-08	7/8"X14	12	8	41	13	48	27
26791-10-10	7/8"X14	16	10	56.5	13	52.5	27
26791-10-12	7/8"X14	20	12	67	13	64	27
26791-12-08	1.1/16"X12	12	8	41	15	49.5	32
26791-12-10	1.1/16"X12	16	10	56.5	15	54	32

F JIC - 74° Cone Seal - 90°
90°美制JIC内螺纹74° 内锥面



26791-W

PART NO 型号	THREAD	HOSE		DIMENSION			
	螺 纹	软管		尺 寸			
	E	DN	DASH	A	C	H	S2
26791-12-12	1.1/16"X12	20	12	65.5	15	63.5	32
26791-12-16	1.1/16"X12	25	16	76.7	15	70	32
26791-14-12	1.3/16"X12	20	12	65.5	15	63.5	36
26791-16-12	1.5/16"X12	20	12	65.5	16	63.5	41
26791-16-16	1.5/16"X12	25	16	76.7	16	70	41
26791-16-20	1.5/16"X12	32	20	91.5	16	81	41
26791-20-20W	1.5/8"X12	32	20	91.5	17	80.5	50
26791-24-20W	1.7/8"X12	32	20	91.5	20	79.5	55
26791-24-24W	1.7/8"X12	40	24	109	20	94	55
26791-32-32W	2.1/2"X12	50	32	133	23.5	122	75

F JIC - 74° Cone Seal - 90°
Compact
90°美制短身JIC内螺纹74° 内锥面

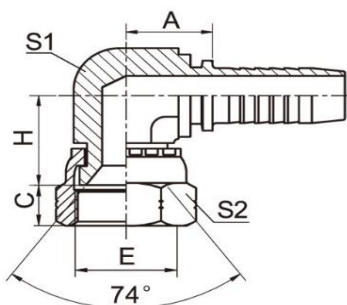

26791-K

PART NO 型号	THREAD	HOSE		DIMENSION				
	螺 纹	软管		尺 寸				
	E	DN	DASH	A	C	H	S1	S2
26791K-04-04	7/16"X20	6	4	17.5	9	18	11	15
26791K-06-04	9/16"X18	6	4	19	10.5	21	14	19
26791K-06-06	9/16"X18	10	6	20	10.5	21	16	19
26791K-08-06	3/4"X16	10	6	23	11	25	19	24
26791K-08-08	3/4"X16	11	8	23.5	11	25	22	24
26791K-10-08	7/8"X14	12	8	23.5	13	27.5	22	27
26791K-10-10	7/8"X14	16	10	25	13	27.5	22	27
26791K-12-12	1.1/16"X12	20	12	27.5	15	30	27	32
26791K-16-16	1.5/16"X12	25	16	43	16	34.3	33	41

M SAE - 90° Cone
美制SAE外螺纹90° 外锥面

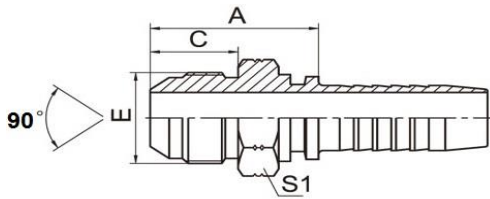

17811

PART NO 型号	THREAD	HOSE		DIMENSION		
	螺纹	软管		尺寸		
	E	DN	DASH	A	C	S1
17811-04-04	7/16"X20	6	4	25.5	12.7	12
17811-05-05	1/2"X20	8	5	27	14.2	14
17811-06-06	5/8"X18	10	6	28.5	15.7	17
17811-08-08	3/4"16	12	8	34	19	22
17811-10-10	7/8"X14	16	10	38.5	22.4	24
17811-12-12	1.1/16"X14	20	12	43.5	25.4	30

F SAE - 90° Cone
美制SAE内螺纹90° 内锥面

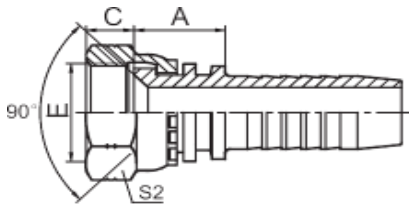

27811

PART NO 型号	THREAD	HOSE		DIMENSION		
	螺纹	软管		尺寸		
	E	DN	DASH	A	C	S2
27811-04-03	7/16"X20	5	3	14	9	15
27811-04-04	7/16"X20	6	4	15	9	15
27811-05-05	1/2"X20	8	5	15.5	9.5	17
27811-06-04	5/8"X18	6	4	17	11.3	22
27811-06-05	5/8"X18	8	5	17	11.3	22
27811-06-06	5/8"X18	10	6	17	11.3	22
27811-08-08	3/4"X16	12	8	18	11	24
27811-10-08	7/8"X14	12	8	18.5	13	27
27811-10-10	7/8"X14	16	10	20	13	27
27811-12-12	1.1/16"X14	20	12	21.5	14.3	32

F SAE - 90° Cone - 45°
45°美制SAE内螺纹90° 内锥面

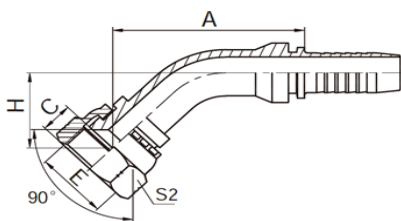

27841

PART NO 型号	THREAD	HOSE		DIMENSION			
	螺纹	软管		尺寸			
	E	DN	DASH	A	C	S1	S2
27841-04-03	7/16"X20	5	3	37.6	9	17.2	15
27841-06-04	5/8"X18	6	4	42	11.3	19.9	22
27841-06-05	5/8"X18	8	5	44.1	11.3	20.7	22
27841-06-06	5/8"X18	10	6	45.7	11.3	21.4	22
27841-08-08	3/4"X16	12	8	58.2	11	23.3	24
27841-10-08	7/8"X14	12	8	58.2	13	23.3	27
27841-10-10	7/8"X14	16	10	69.4	13	24.6	27
27841-12-12	1.1/16"X14	20	12	77.4	14.3	30	32

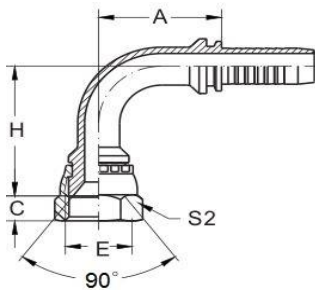
F SAE - 90° Cone - 90°
 90°美制SAE内螺纹90°内锥面

27891

PART NO 型号	THREAD	HOSE		DIMENSION			
	螺纹	软管		尺寸			
	E	DN	DASH	A	H	C	S2
27891-04-03	7/16"X20	5	3	26.5	9	30.5	15
27891-06-04	5/8"X18	6	4	30	11.3	36	22
27891-06-05	5/8"X18	8	5	33	11.3	39	22
27891-06-06	5/8"X18	10	6	35.3	11.3	41.3	22
27891-10-08	7/8"X14	12	8	41	13	47	27
27891-10-10	7/8"X14	16	10	56.5	13	51.5	27
27891-12-12	1.1/16"X14	20	12	65.5	14.3	65.3	32

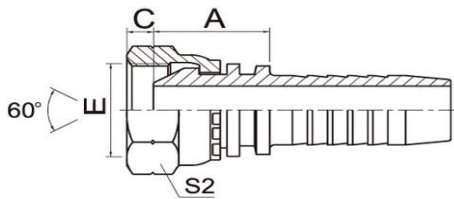
F NPSM 60° CONE SEAL SERIES 美制NPSM内螺纹60°外锥面系列

F NPSM - 60° Cone Seal
 美制NPSM内螺纹60°外锥面

21611

PART NO 型号	THREAD	HOSE		DIMENSION		
	螺纹	软管		尺寸		
	E	DN	DASH	A	C	S2
21611-04-04	1/4"X18	6	4	22	4.6	19
21611-04-06	1/4"X18	10	6	22	4.6	19
21611-06-04	3/8"X18	6	4	23	6	22
21611-06-05	3/8"X18	8	5	23	6	22
21611-06-06	3/8"X18	10	6	23	6	22
21611-08-08	1/2"X14	12	8	23.5	7.5	27
21611-12-10	3/4"X14	16	10	27	8.9	32
21611-12-12	3/4"X14	20	12	27	8.9	32
21611-16-12T	1"X11.5	20	12	25	10.5	41
21611-16-16	1"X11.5	25	16	28.5	10.5	41
21611-20-20W	1.1/4"X11.5	32	20	29.5	11.2	50
21611-24-20T	1.1/2"X11.5	32	20	29.5	11.2	55
21611-24-24W	1.1/2"X11.5	40	24	31.5	11.2	55
21611-32-32W	2"X11.5	50	32	31	11.2	70

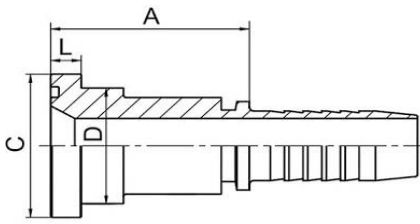
Code 61 Flange - 3,000 PSI
SAE法兰3000PSI



87311

PART NO 型号	SIZE 尺寸	HOSE 软管		DIMENSION 尺寸			
		DN	DASH	A	C	D	L
		87311-08-08	1/2"	12	8	46	30
87311-12-08	3/4"	12	8	47	38	32	7
87311-12-10	3/4"	16	10	48	38	32	7
87311-12-12	3/4"	20	12	48	38	32	7
87311-12-16	3/4"	25	16	49	38	32	7
87311-16-12	1"	20	12	51	44	38	8
87311-16-16	1"	25	16	52	44	38	8
87311-16-20	1"	32	20	53	44	38	8
87311-20-16	1.1/4"	25	16	57	51	43	8
87311-20-20	1.1/4"	32	20	58	51	43	8
87311-24-20	1.1/2"	32	20	68	60	50	8
87311-24-24	1.1/2"	40	24	68	60	50	8
87311-32-24	2"	40	24	70	71	62	10
87311-32-32	2"	50	32	70	71	65	10
87311-40-40	2.1/2"	64	40	76	84	74	10

Code 61 Flange - 3,000 PSI - 45°
45°SAE法兰3000PSI

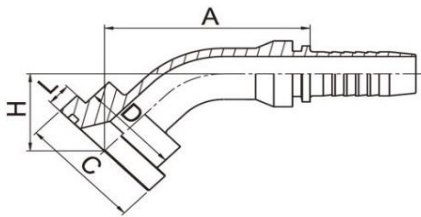

87341

PART NO 型号	SIZE 尺寸	HOSE 软管		DIMENSION 尺寸				
		DN	DASH	A	C	D	H	L
		87341-08-08	1/2"	12	8	58	30	24
87341-12-08	3/4"	12	8	59	38	32	24	7
87341-12-10	3/4"	16	10	70	38	32	25	7
87341-12-12	3/4"	20	12	77	38	32	29	7
87341-16-12	1"	20	12	77	44	38	29	8
87341-16-16	1"	25	16	85	44	38	30	8
87341-16-20	1"	32	20	95	44	38	34	8
87341-20-16	1.1/4"	25	16	85	51	43	30	8
87341-20-20	1.1/4"	32	20	95	51	43	34	8
87341-24-20	1.1/2"	32	20	96	60	50	35	8
87341-24-24	1.1/2"	40	24	110	60	50	39	8
87341-32-24	2"	40	24	110	71	62	39	10
87341-32-32	2"	50	32	129	71	62	46	10

Code 61 Flange - 3,000 PSI - 90°
90°SAE法兰3000PSI

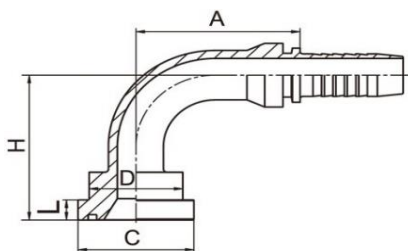

87391

PART NO 型号	SIZE 尺寸	HOSE 软管		DIMENSION 尺寸				
		DN	DASH	A	C	D	H	L
		87391-08-08	1/2"	12	8	41	30.2	24
87391-12-08	3/4"	12	8	41	38.1	31.7	48	6.73
87391-12-10	3/4"	16	10	56.5	37.1	31.7	52.5	6.73
87391-12-12	3/4"	20	12	66.2	38.1	31.7	62	6.73
87391-12-16	3/4"	25	16	76.7	38.1	31.7	67.5	6.73
87391-16-12	1"	20	12	66.2	44.4	38	62	8
87391-16-16	1"	25	16	78	44.4	38	67.5	8
87391-16-20	1"	32	20	91.5	44.4	38	78.5	8
87391-20-16	1.1/4"	25	16	78	50.8	43	67.5	8
87391-20-20	1.1/4"	32	20	91.5	50.8	43	78.5	8

* Continued on next page / 接下页

Code 61 Flange - 3,000 PSI -
90°
90°SAE法兰3000PSI

87391

PART NO 型号	SIZE 尺寸	HOSE 软管		DIMENSION 尺寸				
		DN	DASH	A	C	D	H	L
		87391-24-20	1.1/2"	32	20	92	60	50
87391-24-24	1.1/2"	40	24	109	60	50	94	8
87391-32-24	2"	40	24	109	71	62	94	10
87391-32-32	2"	50	32	132	71	62	114	10
87391-40-32	2.1/2"	50	32	132	84	75	114	10

Code 61 Flange - 3,000 PSI -
90° Long Drop
90°SAE法兰3000PSI

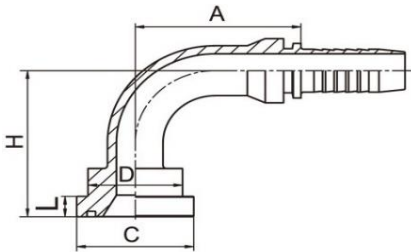

87391-H

PART NO 型号	SIZE 尺寸	HOSE 软管		DIMENSION 尺寸				
		DN	DASH	A	C	D	H	L
		87391-12-12H90	3/4"	20	12	66	38	32
87391-12-12H100	3/4"	20	12	66	38	32	100	7
87391-12-12H127	3/4"	20	12	66	38	32	127	7
87391-12-12H150	3/4"	20	12	66	38	32	150	7
87391-16-16H100	1"	25	16	77	44	38	100	8
87391-16-16H127	1"	25	16	77	44	38	127	8
87391-16-16H150	1"	25	16	77	44	38	150	8
87391-20-20H100	1-1/4"	32	20	92	51	43	100	8
87391-20-20H127	1-1/4"	32	20	92	51	43	127	8
87391-20-20H150	1-1/4"	32	20	92	51	43	150	8
87391-24-24H127	1-1/2"	40	24	109	60	50	127	8
87392-16-12H130	1"	20	12	66	44	38	130	10
87392-16-16H130	1"	25	16	77	44	38	130	10

CODE 62 FLANGE SERIES SAE法兰6000PSI系列

Code 62 Flange - 6,000 PSI
SAE法兰6000PSI

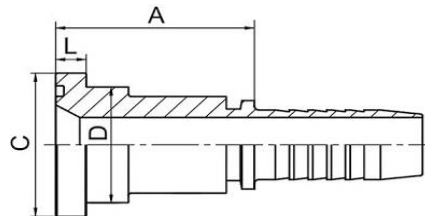

87611

PART NO 型号	SIZE 尺寸	HOSE 软管		DIMENSION 尺寸			
		DN	DASH	A	C	D	L
		87611-08-08	1/2"	12	8	47	32
87611-12-10	3/4"	16	10	51	41	32	9
87611-12-12	3/4"	20	12	51	41	32	9
87611-16-12	1"	20	12	56	48	38	10
87611-16-16	1"	25	16	57	48	38	10
87611-16-20	1"	32	20	61	48	38	10
87611-20-16	1.1/4"	25	16	65	54	44	10
87611-20-20	1.1/4"	32	20	66	54	44	10
87611-24-20	1.1/2"	32	20	75	64	51	13
87611-24-24	1.1/2"	40	24	75	64	51	13
87611-32-24	2"	40	24	85	79	67	13
87611-32-32	2"	50	32	85	79	67	13

Code 62 Flange - 6,000 PSI - 45°

45°SAE法兰3000PSI

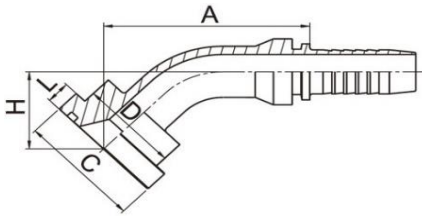
87641

PART NO 型号	SIZE 尺寸	HOSE 软管		DIMENSION 尺寸				
		DN	DASH	A	C	D	H	L
		87641-08-08	1/2"	12	8	59	32	24
87641-08-12	1/2"	20	12	75	32	24	28	8
87641-12-10	3/4"	16	10	73	41	32	28	9
87641-12-12	3/4"	20	12	79	41	32	32	9
87641-16-16	1"	25	16	90	48	38	35	10
87641-20-20	1.1/4"	32	20	104	54	44	42	10
87641-24-20	1.1/2"	32	20	106	64	51	45	13
87641-24-24	1.1/2"	40	24	116	64	51	46	13
87641-32-24	2"	40	24	125	79	67	55	13
87641-32-32	2"	50	32	136	79	67	53	13

Code 62 Flange - 6,000 PSI - 90°

90°SAE法兰3000PSI

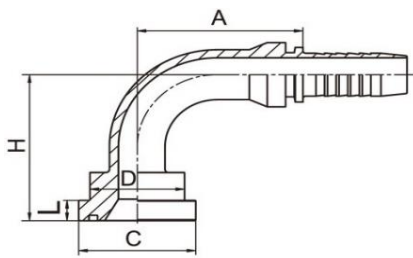
87691

PART NO 型号	SIZE 尺寸	HOSE 软管		DIMENSION 尺寸				
		DN	DASH	A	C	D	H	L
		87691-08-08	1/2"	12	8	41	31.7	24
87691-12-10	3/4"	16	10	56	41.3	32	56.5	8.76
87691-12-12	3/4"	20	12	65.5	41.3	32	66	8.76
87691-16-12	1"	20	12	65.5	47.6	38	69	9.53
87691-16-16	1"	25	16	76.7	47.6	38	74.5	9.53
87691-16-20	1"	32	20	91.5	47.6	38	85.5	9.53
87691-20-16	1-1/4"	25	16	76.7	54	44	78.5	10.3
87691-20-20	1-1/4"	32	20	91.5	54	44	89.5	10.3
87691-24-20	1-1/2"	32	20	91.5	63.5	51	94.5	12.6
87691-24-24	1-1/2"	40	24	109	63.5	51	108	12.6
87691-32-24	2"	40	24	109	79.4	67	116	12.6
87691-32-32	2"	50	32	132	79.4	67	136	12.6

Code 62 Flange - 6,000 PSI - 90° - Long Drop

SAE法兰6000PSI

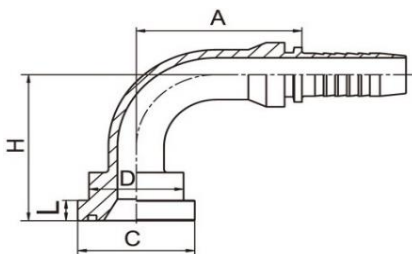
87691-H

PART NO 型号	SIZE 尺寸	HOSE 软管		DIMENSION 尺寸				
		DN	DASH	A	C	D	H	L
		87691-12-12H90	3/4"	20	12	65.5	41.3	32
87691-12-12H100	3/4"	20	12	65.5	41.3	32	100	8.76
87691-12-12H127	3/4"	20	12	65.5	41.3	32	127	8.76
87691-12-12H150	3/4"	20	12	65.5	41.3	32	150	8.76
87691-16-16H100	1"	25	16	76.7	47.6	38	100	9.53
87691-16-16H127	1"	25	16	76.7	47.6	38	127	9.53
87691-16-16H150	1"	25	16	76.7	47.6	38	150	9.53
87691-20-20H100	1-1/4"	32	20	91.5	54	44	100	10.3
87691-20-20H127	1-1/4"	32	20	91.5	54	44	127	10.3
87691-20-20H150	1-1/4"	32	20	91.5	54	44	150	10.3
87691-24-24H127	1-1/2"	40	24	109	60.3	50	127	8

CODE 61 SPLIT FLANGE
SAE对开法兰夹3000PSI

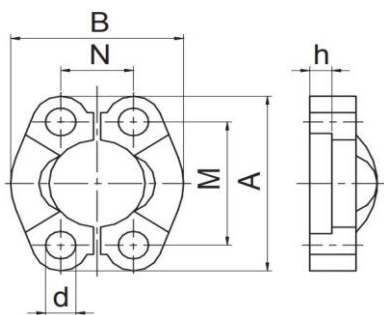

FL

PART NO 型号	SIZE 尺寸	DIMENSION 尺寸						BOLT 螺栓	W. P. 压力 Mpa
		A	B	M	d	N	h		
FL-08	1/2"	54	46	38	9	18	38	M8X25	34.5
FL-12	3/4"	65	52	48	11	22	48	M10X30	
FL-16	1"	70	59	52	11	26	52	M10X30	
FL-20	1.1/4"	79	73	59	11	30	59	M10X30	27.6
FL-24	1.1/2"	94	83	70	14	36	70	M12X35	20.7
FL-32	2"	102	97	78	14	43	78	M12X35	
FL-40	2.1/2"	114	109	89	14	51	89	M12X40	10
FL-48	3"	135	131	106	18	62	106	M16X50	

CODE 62 SPLIT FLANGE SAE对开法兰夹6000PSI

CODE 62 SPLIT FLANGE
SAE对开法兰夹6000PSI

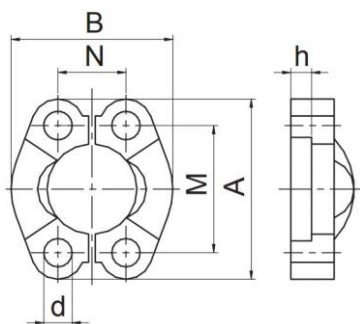

FS

PART NO 型号	SIZE 尺寸	DIMENSION 尺寸						BOLT 螺栓	W. P. 压力 Mpa
		A	B	M	d	N	h		
FS-08	1/2"	56	49	41	9	18	41	M8X30	42
FS-12	3/4"	71	62	51	11	24	51	M10X35	
FS-16	1"	81	71	57	13	28	57	M12X45	
FS-20	1.1/4"	95	79	67	15	32	67	M14X50	
FS-24	1.1/2"	113	97	79	17	37	79	M16X55	
FS-32	2"	133	116	97	21	44	97	M20X70	

JIS METRIC 60° CONE SEAL SERIES 日本公制螺纹60°锥面系列

M JIS Metric - 60° Cone Seal
日本公制外螺纹60°外锥面

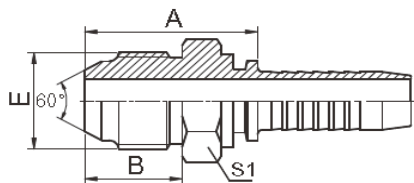

18611

PART NO 型号	THREAD 螺纹	HOSE 软管		DIMENSION 尺寸		
	E	DN	DASH	A	B	S1
18611-14-04	M14X1.5	6	4	30	17	17
18611-14-06	M14X1.5	10	6	30	17	17
18611-16-04	M16X1.5	6	4	31	18	17
18611-16-06	M16X1.5	10	6	31	18	17
18611-18-06	M18X1.5	10	6	31	18	19
18611-20-08	M20X1.5	12	8	35	20	22
18611-22-08	M22X1.5	12	8	35	20	24
18611-24-10	M24X1.5	16	10	40	22	27
18611-30-12	M30X1.5	20	12	45	26	32
18611-33-16	M33X1.5	25	16	51	30	36
18611-36-20	M36X1.5	32	20	55	33	38
18611-42-24	M42X1.5	40	24	60	36	46

F JIS Metric - 60° Cone Seal
日本公制内螺纹60° 内锥面

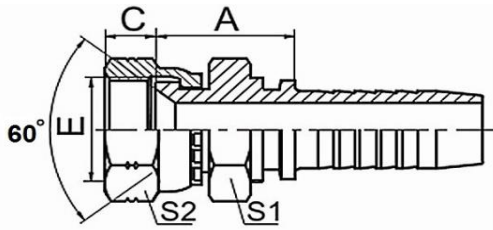

28611

PART NO 型号	THREAD	HOSE		DIMENSION			
	螺 纹	软管		尺 寸			
	E	DN	DASH	A	C	S1	S2
28611-12-04	M12X1.5	6	4	20	9	17	17
28611-14-04	M14X1.5	6	4	21	11	19	19
28611-14-06	M14X1.5	10	6	21	11	19	19
28611-16-04	M16X1.5	6	4	24	10	22	22
28611-16-05	M16X1.5	8	5	24	10	22	22
28611-16-06	M16X1.5	10	6	24	10	22	22
28611-18-06	M18X1.5	10	6	25	12	24	24
28611-18-08	M18X1.5	12	8	25	12	24	24
28611-20-08	M20X1.5	12	8	29	12	27	27
28611-22-08	M22X1.5	12	8	26	14	27	27
28611-24-08	M24X1.5	12	8	28	15	32	32
28611-24-10	M24X1.5	16	10	29	15	32	32
28611-27-10	M27X1.5	16	10	29	10	32	32
28611-30-12	M30X1.5	20	12	29	18	36	36
28611-33-12	M33X1.5	20	12	31	21	41	41
28611-33-16	M33X1.5	25	16	32	21	41	41
28611-36-20	M36X1.5	32	20	36	20	46	46
28611-42-24W	M42X1.5	40	24	36	19	55	55

F JIS Metric - 60° Cone Seal - 45°
45°日本公制内螺纹60° 内锥

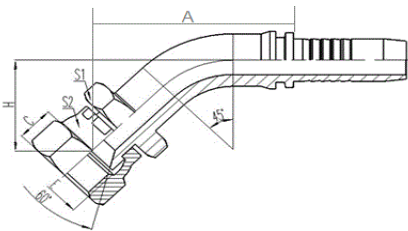

28641

PART NO 型号	THREAD	HOSE		DIMENSION				
	螺 纹	软管		尺 寸				
	E	DN	DASH	A	C	H	S1	S2
28641-14-04	M14X1.5	6	4	43	11	21	19	19
28641-16-05	M16X1.5	8	5	48	10	24	22	22
28641-18-06	M18X1.5	10	6	49	12	25	24	24
28641-22-06	M22X1.5	12	8	62	14	27	27	27
28641-24-10	M24X1.5	16	10	75	15	30	32	32
28641-30-12	M30X1.5	20	12	81	18	34	36	36
28641-33-16	M33X1.5	25	16	90	21	36	41	41
28641-36-20	M36X1.5	32	20	104	20	42	46	46
28641-42-24W	M42X1.5	40	24	116	19	46	50	55

F JIS Metric - 60° Cone Seal - 90°
90°日本公制内螺纹60° 内锥面

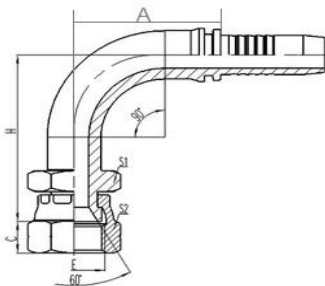

28691

PART NO 型号	THREAD	HOSE		DIMENSION				
	螺 纹	软管		尺 寸				
	E	DN	DASH	A	C	H	S1	S2
28691-14-04	M14X1.5	6	4	30	11	38	19	19
28691-14-06	M14X1.5	10	6	36	11	43	19	19
28691-16-05	M16X1.5	8	5	33	10	44	22	22
28691-18-06	M18X1.5	10	6	35	12	46	24	24
28691-22-08	M22X1.5	12	8	41	14	53	27	27
28691-24-10	M24X1.5	16	10	57	15	59	32	32
28691-30-2	M30X1.5	20	12	66	18	69	36	36
28691-33-16	M33X1.5	25	16	77	21	76	41	41
28691-36-20	M36X1.5	32	20	93	20	90	46	46
28691-42-24W	M42X1.5	40	24	109	19	103	55	55

M JIS GAS - 60° Cone Seal
日本英管外螺纹60° 外锥面

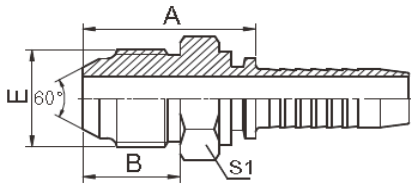

19611

PART NO 型号	THREAD 螺纹	HOSE 软管		DIMENSION 尺寸		
	E	DN	DASH	A	B	S1
	19611-04-04	G1/4x19	6	6	29	16
19611-06-06	G3/8x19	10	10	31	18	19
19611-08-08	G1/2x14	12	12	35	20	22
19611-12-12	G3/4x14	20	20	41	22	30
19611-16-16	G1x11	25	25	44	24	36

F JIS GAS - 60° Cone Seal
日本英管制内螺纹60° 内锥面

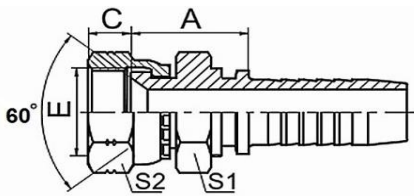

29611

PART NO 型号	THREAD 螺纹	HOSE 软管		DIMENSION 尺寸			
	E	DN	DASH	A	C	S1	S2
	29611-02-03	G1/8"X28	5	3	20	7	14
29611-04-04	G1/4"X19	6	4	21	8	19	19
29611-04-05	G1/4"X19	8	5	21	8	19	19
29611-06-04	G3/8"X19	6	4	24	9	22	22
29611-06-06	G3/8"X19	10	6	23	9	22	22
29611-08-06	G1/2"X14	10	6	28	12	27	27
29611-08-08	G1/2"X14	12	8	27	12	27	27
29611-10-10	G5/8"X14	16	10	31	12	30	30
29611-12-10	G3/4"X14	16	10	29	14	32	32
29611-12-12	G3/4"X14	20	12	29	14	32	32
29611-16-16	G1"X11	25	16	32	16	41	41
29611-20-20W	G1.1/4"X11	32	20	43	19	50	50
29611-24-24W	G1.1/2"X11	40	24	44	19	55	55
29611-32-32W	G2"X11	50	32	47	23	70	70

F JIS GAS - 60° Cone Seal - 45°
45°日本英管内螺纹60° 内锥

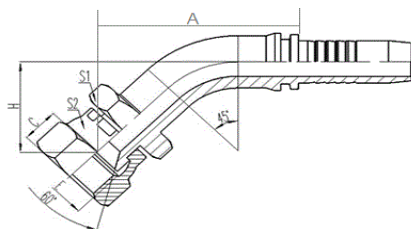

29641

PART NO 型号	THREAD 螺纹	HOSE 软管		DIMENSION 尺寸				
	E	DN	DASH	A	C	H	S1	S2
	29641-04-04	G1/4"X19	6	4	43.4	8	21.3	19
29641-06-06	G3/8"X19	10	6	48.9	9	24.6	22	22
29641-08-08	G1/2"X14	12	8	62.5	12	27.5	27	27
29641-12-12	G3/4"X14	20	12	81.3	13.5	33.9	32	32
29641-16-16	G1"X11	25	16	87.3	16	36	41	41
29641-20-20W	G1.1/4"X11	32	20	107	18.5	46.5	50	50
29641-24-24W	G1.1/2"X11	40	24	123	19	50.8	55	55
29641-32-32W	G2"X11	50	32	143	23	60	70	70

F JIS GAS - 60° Cone Seal - 90°
90°日本英管内螺纹60° 内锥

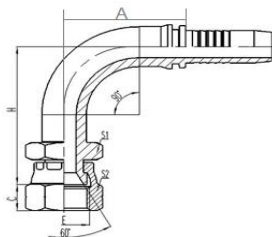

29691

PART NO 型号	THREAD 螺纹	HOSE 软管		DIMENSION 尺寸				
	E	DN	DASH	A	C	H	S1	S2
29641-04-04	G1/4"X19	6	4	43.4	8	21.3	19	19
29641-06-06	G3/8"X19	10	6	48.9	9	24.6	22	22
29641-08-08	G1/2"X14	12	8	62.5	12	27.5	27	27
29641-12-12	G3/4"X14	20	12	81.3	13.5	33.9	32	32
29641-16-16	G1"X11	25	16	87.3	16	36	41	41
29641-20-20W	G1.1/4"X11	32	20	107	18.5	46.5	50	50
29641-24-24W	G1.1/2"X11	40	24	123	19	50.8	55	55
29641-32-32W	G2"X11	50	32	143	23	60	70	70

JIS KOMATSU FLANGE SERIES 日制法兰系列

JIS KOMATSU Flange 日制法兰

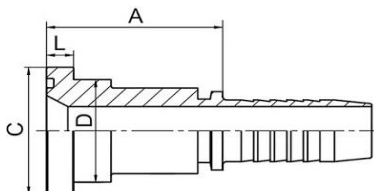

88111

PART NO 型号	SIZE 尺寸	HOSE 软管		DIMENSION 尺寸			
		DN	DASH	A	C	D	L
88111-10-08	5/8"	12	8	45	34	28	7
88111-10-10	5/8"	16	10	46	34	28	7
88111-10-12	5/8"	20	12	46	34	28	7

JIS KOMATSU Flange - 45° 45°日制法兰

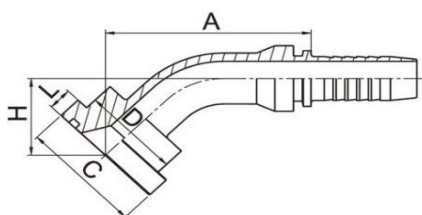

88141

PART NO 型号	SIZE 尺寸	HOSE 软管		DIMENSION 尺寸				
		DN	DASH	A	C	D	H	L
88141-10-08	5/8"	12	8	59	34	28	24	7
88141-10-10	5/8"	16	10	70	34	28	25	7
88141-10-12	5/8"	20	12	77	34	28	29	7

JIS KOMATSU Flange - 90° 90°日制法兰

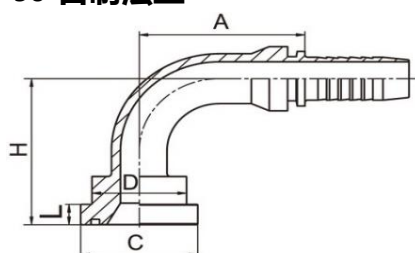

88191

PART NO 型号	SIZE 尺寸	HOSE 软管		DIMENSION 尺寸				
		DN	DASH	A	C	D	H	L
88191-10-08	5/8"	12	8	41	34	28	48	7
88191-10-10	5/8"	16	10	56	34	28	53	7
88191-10-12	5/8"	20	12	66	34	28	62	7

M SAE STAPLE-LOK 煤炭部标准矿用接头

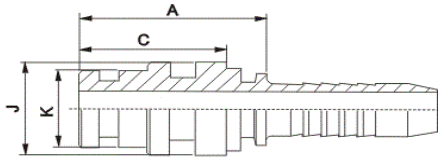

60011

PART NO 型号	HOSE 软管		DIMENSION 尺寸			
	DN	DASH	A	C	S1	S2
60011-04-04	6	4	31	25	15	11
60011-05-05	8	5	34	26	18	13
60011-06-06	10	6	33	26	18	15
60011-08-06	10	6	34	26	22	18
60011-08-08	12	8	34	26	22	18
60011-10-10	16	10	39	30	25	20
60011-12-12	20	12	41	31	28	24
60011-16-14	22	14	41	31	35	30
60011-16-16	25	16	42	31	35	30

METRIC WATER INSERT FITTING 公制内螺纹高压水管接头

F Metric Waterwash Inserts 公制内螺纹高压水管接头

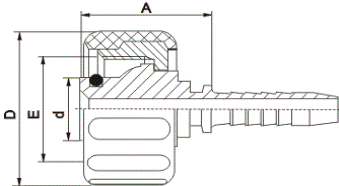

20011-ST

PART NO 型号	THREAD 螺纹	HOSE 软管		DIMENSION 尺寸			
	E	DN	DASH	A	C	J	K
20011-22-03ST	M22x1.5	5	3	24.5	14	34.5	19
20011-22-04ST	M22x1.5	6	4	25	14	34.5	22
20011-22-05ST	M22x1.5	8	5	25	14	34.5	27
20011-22-06ST	M22x1.5	10	6	25	14	34.5	32

DOUBLE CONNECTOR 双面连接芯

Double Connector 双面连接芯

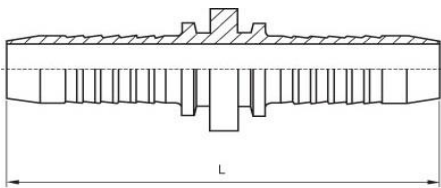

90011/90012

*
90011 is used with wire braid hose,
90012 is used with wire spiral hose.

90011适用于编织软管;
90012适用于缠绕软管。

PART NO 型号	HOSE 软管		DIMENSION 尺寸
	DN	DASH	L
90011-04	6	4	69
90011-05	8	5	69
90011-06	10	6	73
90011-08	12	8	77
90011-10	16	10	83
90011-12	20	12	93
90011-16	25	16	114
90011-20	32	20	132
90011-24	40	24	162
90011-32	50	32	170
90012-04	6	4	83
90012-05	8	5	87
90012-06	10	6	87
90012-08	12	8	91
90012-10	16	10	97
90012-12	20	12	110
90012-16	25	16	134
90012-20	32	20	153
90012-24	40	24	172
90012-32	50	32	178

JB Metric Banjo
公制铰接体

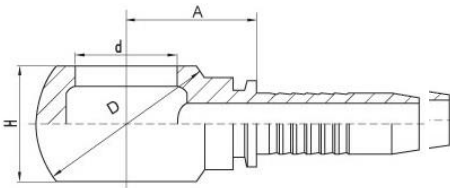

70011

PART NO 型号	THREAD	HOSE		DIMENSION			
	螺 纹	软管		尺 寸			
	E	DN	DASH	A	C	J	K
70011-10-03	M10X1	5	3	14.5	10.1	17	10
70011-10-04	M10X1	6	4	17	10.1	17	10
70011-12-04	M12X1.5	6	4	20.5	12.1	20	12
70011-12-05	M12X1.5	8	5	20.5	12.1	20	12
70011-12-06	M12X1.5	10	6	20.5	12	20	12
70011-14-04	M14X1.5	6	4	21	14	24	14
70011-14-05	M14X1.5	8	5	21	14	24	14
70011-14-06	M14X1.5	10	6	21	14	24	14
70011-16-04	M16X1.5	6	4	20.5	16	28	16
70011-16-05	M16X1.5	8	5	20.5	16	28	16
70011-16-06	M16X1.5	10	6	20.5	16	28	16
70011-18-04	M18X1.5	6	4	23	18	32	20
70011-18-05	M18X1.5	8	5	24	18	32	20
70011-18-06	M18X1.5	10	6	24	18	32	20
70011-18-08	M18X1.5	12	8	24.5	18	32	20
70011-22-06	M22X1.5	10	6	28.1	22	39	25
70011-22-08	M22X1.5	12	8	28.5	22	39	25
70011-22-10	M22X1.5	16	10	28	22	39	25
70011-26-12	M26X1.5	20	12	32.5	26	46	30
70011-30-16	M30X1.5	25	16	37	30	54	36
70011-30-20	M30X1.5	32	20	40	30	54	36

JB Metric Bolt
公制铰接螺栓

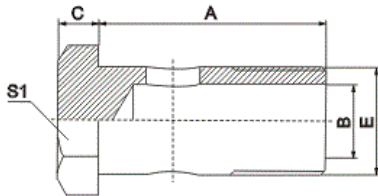

700M

PART NO 型号	THREAD	DIMENSION			
	螺 纹	尺 寸			
	E	A	C	J	K
700M-10	M10x1	19	4	6	6
700M-12	M12x1.5	24	6	6	6
700M-14	M14x1.5	26	8	7	7
700M-16	M16x1.5	28	9	7.5	7.5
700M-18	M18x1.5	32	11	8	8
700M-22	M22x1.5	39	14	9	9
700M-26	M26x1.5	45	18	10	10
700M-30	M30x1.5	51	22	11	11

JB Metric Banjo
公制铰接体

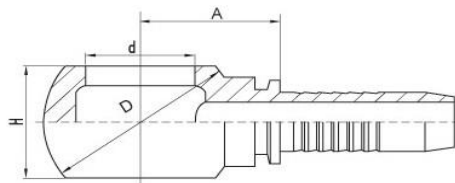

71011

PART NO 型号	THREAD	HOSE		DIMENSION			
	螺纹	软管		尺寸			
	E	DN	DASH	A	C	J	K
71011-06-04	M6x1	6	4	16	6	18	12
71011-08-04	M8x1	6	4	17	8	20	13
71011-10-04	M10x1	6	4	19	10	22	13
71011-10-05	M10x1	8	5	19	10	22	13
71011-10-06	M10x1	10	6	19	10	22	13
71011-12-06	M12x1.5	10	6	21	12	26	15
71011-14-04	M14x1.5	6	4	20.5	14	28	18
71011-14-05	M14x1.5	8	5	21.5	14	28	18
71011-14-06	M14x1.5	10	6	21.5	14	28	18
71011-14-08	M14x1.5	12	8	22.5	14	28	18
71011-16-05	M16x1.5	8	5	22.5	16	32	18
71011-16-08	M16x1.5	12	8	25	16	32	18
71011-18-06	M18x1.5	10	6	26.5	18	36	22
71011-18-08	M18x1.5	12	8	27	18	36	22
71011-18-10	M18x1.5	16	10	27.5	18	36	22
71011-20-06	M20x1.5	10	6	29.5	20	36	22
71011-20-08	M20x1.5	12	8	30	20	36	22
71011-22-10	M22x1.5	16	10	30.5	22	46	30
71011-22-12	M22x1.5	20	12	32	22	46	30
71011-27-10	M27x2	16	10	36.5	27	56	36
71011-27-14	M27x2	22	14	36	27	56	36
71011-27-16	M27x2	25	16	36	27	56	36
71011-33-12	M33x2	20	12	43	33	64	50
71011-42-20	M42x2	32	20	54	42	78	64

JB Metric Bolt
公制铰接螺栓

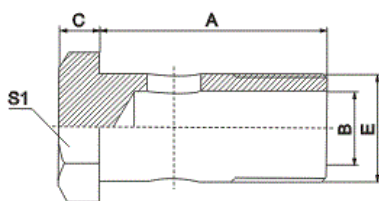

710M

PART NO 型号	THREAD	DIMENSION			
	螺纹	尺寸			
	E	A	C	J	K
700M-10	M10x1	19	4	6	6
700M-12	M12x1.5	24	6	6	6
700M-14	M14x1.5	26	8	7	7
700M-16	M16x1.5	28	9	7.5	7.5
700M-18	M18x1.5	32	11	8	8
700M-22	M22x1.5	39	14	9	9
700M-26	M26x1.5	45	18	10	10
700M-30	M30x1.5	51	22	11	11

BSP Banjo
英制铰接体

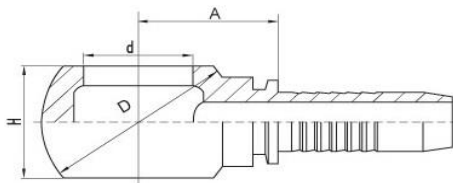

72011

PART NO 型号	THREAD	HOSE		DIMENSION			
	螺纹	软管		尺寸			
	E	DN	DASH	A	C	J	K
72011-02-03	G1/8x28	5	3	18	9.9	24	16
72011-02-04	G1/8x28	6	4	18.5	9.9	24	16
72011-04-03	G1/4x19	5	3	19	13.3	24	15
72011-04-04	G1/4x19	6	4	19.5	13.3	24	15
72011-04-05	G1/4x19	8	5	19.5	13	24	15
72011-04-06	G1/4x19	10	6	19.5	13	24	15
72011-06-04	G3/8x19	6	4	22	17	29	20
72011-06-05	G3/8x19	8	5	22.5	17	29	20
72011-06-06	G3/8x19	10	6	22.5	17	29	20
72011-06-08	G3/8x19	12	8	23	17	29	20
72011-08-05	G1/2x14	8	5	27.5	21	38	25
72011-08-06	G1/2x14	10	6	27.5	21	38	25
72011-08-08	G1/2x14	12	8	28	21	38	25
72011-08-10	G1/2x14	16	10	28.5	21	38	25
72011-10-10	G5/8x14	16	10	30	23	40	27
72011-12-10	G3/4x14	16	10	31.5	27	48	31
72011-12-12	G3/4x14	20	12	32	27	48	31
72011-16-08	G1x11	12	8	40	33	60	42
72011-16-12	G1x11	20	12	40	33	60	42
72011-16-16	G1x11	25	16	41	33	60	42

BSP Bolt
英制铰接螺栓

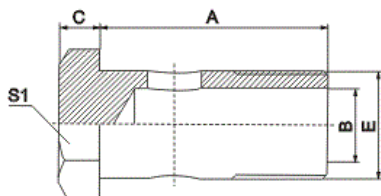

720B

PART NO 型号	THREAD	DIMENSION			
	螺纹	尺寸			
	E	A	C	J	K
720B-02	G1/8x28	29.5	4.8	4.8	14
720B-04	G1/4x19	28.5	6	6	19
720B-06	G3/8x19	38.5	9	7	22
720B-08	G1/2x14	44	13	8.5	27
720B-10	G5/8x14	48.5	15	10	30
720B-12	G3/4x14	56	18	10	32
720B-16	G1x11	68.5	22	13	41

M Metric S - 24° Cone 公制外螺纹24°内锥面轻系列

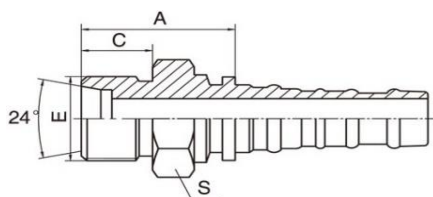

10513

PART NO 型号	THREAD 螺纹	HOSE 软管		TUBE 硬管	DIMENSION 尺寸		
	E	DN	DASH	OD	A	C	S
10513-36-12	M36x2	20	12	25	44	18	41
10513-42-16	M42x2	25	16	30	46	20	46
10513-52-20	M52x2	32	20	38	53	22	55

F Metric S - 24° Cone with O-Ring 公制内螺纹24°内锥面重系列

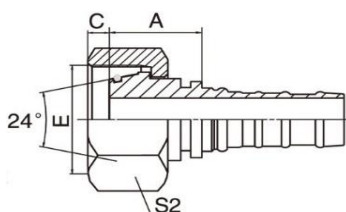

20513

PART NO 型号	THREAD 螺纹	HOSE 软管		TUBE 硬管	DIMENSION 尺寸		
	E	DN	DASH	OD	A	C	S2
20513-30-12W	M30X2	20	12	20	30	3	36
20513-36-16W	M36X2	25	16	25	32	3	41
20513-42-16W	M42X2	25	16	30	33	5	50
20513-42-20W	M42X2	32	20	30	39	5	50
20513-52-24W	M52X2	40	24	38	38	7	60
20513-36-12T	M36X2	20	12	25	39	3	41
20513-42-12T	M42X2	20	12	30	42	5	50
20513-52-20T	M52X2	32	20	38	45	7	60

F Metric S - 24° Cone with O-Ring - 45° 45°公制内螺纹24°内锥面重系列

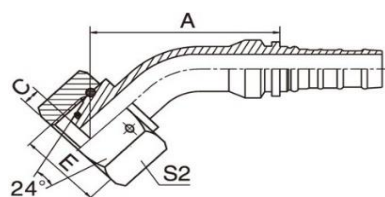

20543

PART NO 型号	THREAD 螺纹	HOSE 软管		TUBE 硬管	DIMENSION 尺寸			
	E	DN	DASH	OD	A	C	H	S2
20543-36-12T	M36X2	20	12	25	89	3	33	41
20543-42-16W	M42X2	25	16	30	102	5	36	50
20543-52-20T	M52X2	32	20	38	115	7	39	60

F Metric S - 24° Cone with O-Ring - 90° 90°公制内螺纹24°内锥面重系列

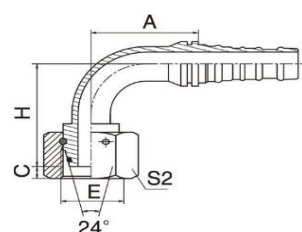

20593

PART NO 型号	THREAD 螺纹	HOSE 软管		TUBE 硬管	DIMENSION 尺寸			
	E	DN	DASH	OD	A	C	H	S2
20593-36-12T	M36x2	20	12	25	75	5	68	46
20593-36-16	M36x2	25	16	25	89	5	80	46
20593-42-16	M42x2	25	16	30	89	6	81	50
20593-42-20	M42x2	32	20	30	106	6	92	50
20593-52-20T	M52x2	32	20	38	106	7	87	60
20593-52-24	M52x2	40	24	38	124	7	105	60

M BSP - 60° Cone Seal
英管外螺纹60° 内锥面

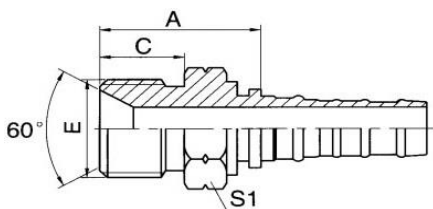

10513

PART NO 型 号	THREAD	HOSE		DIMENSION		
	螺 纹	软管		尺 寸		
	E	DN	DASH	A	C	S1
12613-12-12	G3/4x14	20	12	40	19	30
12613-16-16	G1x11	25	16	45	20	38
12613-20-20	G1-1/4x11	32	20	49	20	46
12613-24-24	G1-1/2x11	40	24	53	22	50
12613-32-32	G2x11	50	32	59	25	65

F BSP - 60° Cone Seal
英管内螺纹60° 外锥面

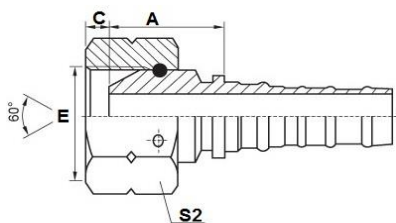

22613

PART NO 型 号	THREAD	HOSE		DIMENSION		
	螺 纹	软管		尺 寸		
	E	DN	DASH	A	C	S2
22613-12-12W	G3/4x14	20	12	28	9	32
22613-16-16W	G1x11	25	16	32	11	41
22613-20-20W	G1-1/4x11	32	20	36	10	50
22613-24-24W	G1-1/2x11	40	24	37	13	55
22613-32-32W	G2x11	50	32	37	16	70

F BSP - 60° Cone Seal - 45°
45°英管内螺纹60° 外锥面

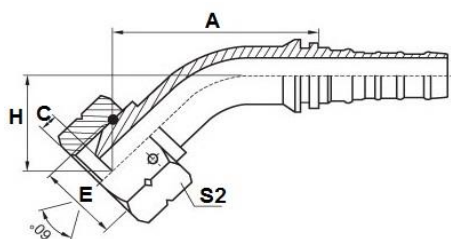

22643

PART NO 型 号	THREAD	HOSE		DIMENSION			
	螺 纹	软管		尺 寸			
	E	DN	DASH	A	C	H	S2
22643-12-12W	G3/4"X14	20	12	88	11	33	32
22643-16-16W	G1"X11	25	16	99	12	33	41
22643-20-20W	G1.1/4"X11	32	20	113	11	38	50
22643-24-24W	G1.1/2"X11	40	24	131	13	46	55
22643-32-32W	G2"X11	50	32	155	16	53	70

F BSP - 60° Cone Seal - 90°
90°英管内螺纹60° 外锥面

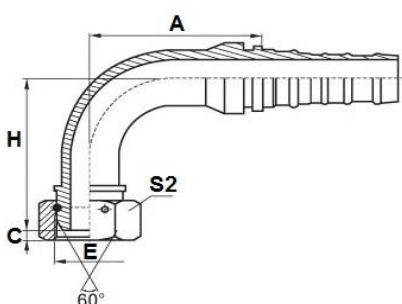

22693

PART NO 型 号	THREAD	HOSE		DIMENSION			
	螺 纹	软管		尺 寸			
	E	DN	DASH	A	C	H	S2
22693-12-12W	G3/4"X14	20	12	74	11	67	32
22693-16-16W	G1"X11	25	16	92	12	72	41
22693-20-20W	G1.1/4"X11	32	20	106	11	88	50
22693-24-24W	G1.1/2"X11	40	24	124	14	103	55
22693-32-32W	G2"X11	50	32	149	16	123	70

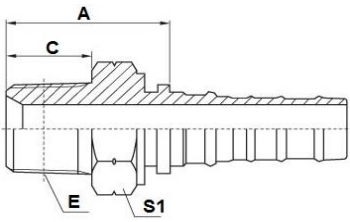
M BSPT
英锥管外螺纹

PART NO 型号	THREAD	HOSE		DIMENSION		
	螺纹	软管		尺寸		
	E	DN	DASH	A	C	S1
13013-12-12SP	R3/4"X14	20	12	38	20	30
13013-16-16SP	R1"X11	25	16	46	26	38
13013-20-20SP	R1.1/4"X11	32	20	51	27	46
13013-24-24SP	R1.1/2"X11	40	24	53	27	50
13013-32-32SP	R2"X11	50	32	59	30	65

13013-SP

MALE NPT SERIES 布锥管外螺纹

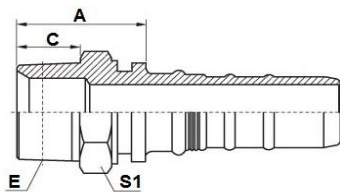
M NPT
布锥管外螺纹

PART NO 型号	THREAD	HOSE		DIMENSION		
	螺纹	软管		尺寸		
	E	DN	DASH	A	C	S2
15613-12-12	Z3/4X14	20	12	39.5	19.05	30
15613-16-16	Z1X11.5	25	16	47.9	23.88	38
15613-20-20	Z1-1/4X11.5	32	20	53.8	24.64	46
15613-24-24	Z1-1/2X11.5	40	24	58.2	25.4	50
15613-32-32	Z2X11.5	50	32	61	26.16	65

15613

F NPSM 60° CONE SEAL SERIES 美制NPSM内螺纹60° 外锥面系列

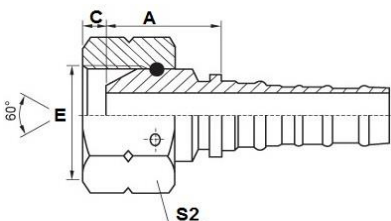
F NPSM - 60° Cone Seal
美制NPSM内螺纹60° 外锥面

PART NO 型号	THREAD	HOSE		DIMENSION		
	螺纹	软管		尺寸		
	E	DN	DASH	A	C	S2
21613-12-12W	3/4X14	20	12	27	9	32
21613-16-16W	1X11.5	25	16	30	9	41
21613-20-20W	1-1/4X11.5	32	20	33	11	50
21613-24-24W	1-1/2X11.5	40	24	37	11	55
21613-32-32W	2X11.5	50	32	37	11	70

21613-W

F ORFS - Flat Seal 美制ORFS内螺纹平面O形圈密封

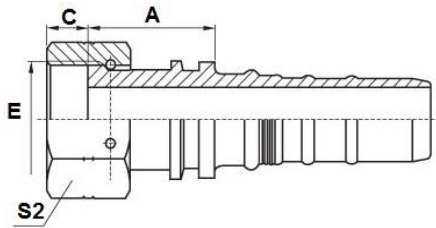

24213

PART NO 型号	THREAD	HOSE		DIMENSION		
	螺 纹	软管		尺 寸		
	E	DN	DASH	A	C	S1
24213-12-12W	1.3/16"X12	20	12	41	15	36
24213-16-16W	1.7/16"X12	25	16	44	15	41
24213-20-20W	1.11/16"X12	32	20	48	15	50
24213-24-24W	2"X12	40	24	48	15	60

F ORFS - Flat Seal - 45° 45°美制ORFS内螺纹平面O形圈密封

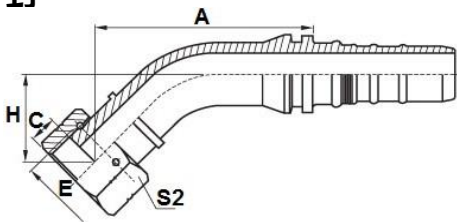

24243

PART NO 型号	THREAD	HOSE		DIMENSION			
	螺 纹	软管		尺 寸			
	E	DN	DASH	A	C	H	S2
24243-12-12W	1.3/16"X12	20	12	97.7	15	42	36
24243-16-16W	1.7/16"X12	25	16	111	15	44.6	41
24243-20-20W	1.11/16"X12	32	20	124	15	49	50
24243-24-24W	2"X12	40	24	138	14.8	53.6	60

F ORFS - Flat Seal - 90° 90°美制ORFS内螺纹平面O形圈密封

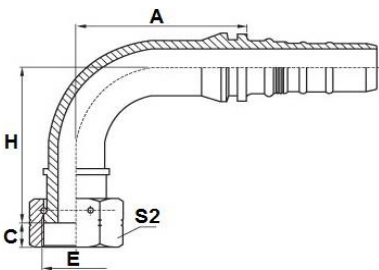

24293

PART NO 型号	THREAD	HOSE		DIMENSION			
	螺 纹	软管		尺 寸			
	E	DN	DASH	A	C	H	S2
24293-12-12W	1.3/16"X12	20	12	74	15	81	36
24293-16-16W	1.7/16"X12	25	16	89	15	89	41
24293-20-20W	1.11/16"X12	32	20	106	15	100	50
24293-24-24W	2"X12	40	24	123	15	115	60

F JIC - 74° Cone Seal
美制JIC内螺纹74°内锥面

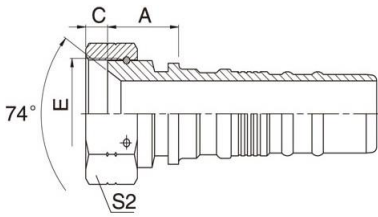

26713-W

PART NO 型号	THREAD	HOSE		DIMENSION		
	螺纹	软管		尺寸		
	E	DN	DASH	A	C	S1
26713-12-12W	1.1/16"X12	20	12	27	15	32
26713-16-16W	1.5/16"X12	25	16	29	16	41
26713-20-20W	1.5/8"X12	32	20	32	17	50
26713-24-24W	1.7/8"X12	40	24	35	20	60
26713-32-32W	2.1/2"X12	50	32	35	24	75

F JIC - 74° Cone Seal - 45°
45°美制JIC内螺纹74°内锥面

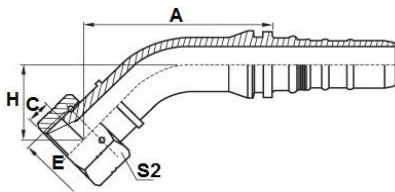

26743-W

PART NO 型号	THREAD	HOSE		DIMENSION			
	螺纹	软管		尺寸			
	E	DN	DASH	A	C	H	S2
26743-12-12W	1.1/16"X12	20	12	86.4	15	30	32
26743-16-16W	1.5/16"X12	25	16	101	16	31.5	41
26743-20-20W	1.5/8"X12	32	20	113	17	36.6	50
26743-24-24W	1.7/8"X12	40	24	126	20	41.6	55
26743-32-32W	2.1/2"X12	50	32	149	24	49	75

F JIC - 74° Cone Seal - 90°
90°美制JIC内螺纹74°内锥面

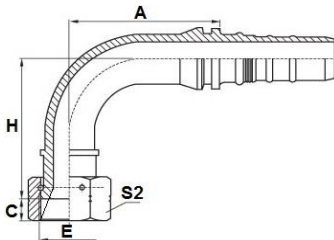

26793-W

PART NO 型号	THREAD	HOSE		DIMENSION			
	螺纹	软管		尺寸			
	E	DN	DASH	A	C	H	S2
26793-12-12W	1.1/16"X12	20	12	74	15	65	32
26793-16-16W	1.5/16"X12	25	16	89	16	73	41
26793-20-20W	1.5/8"X12	32	20	106	17	82	50
26793-24-24W	1.7/8"X12	40	24	124	20	101	55
26793-32-32W	2.1/2"X12	50	32	150	24	121	75

F JIC - 74° Cone Seal - Double Hexagon
美制JIC内螺纹74°内锥面双对边

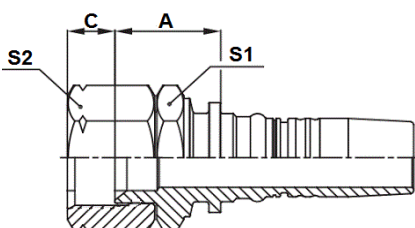

26713D-W

PART NO 型号	THREAD	HOSE		DIMENSION			
	螺纹	软管		尺寸			
	E	DN	DASH	A	C	H	S2
26713D-12-12W	1-1/16x12	20	12	37.5	14.3	30	32
26713D-16-16W	1-5/16x12	25	16	41.9	15.1	38	41
26713D-20-20W	1-5/8x12	32	20	45.3	16.5	46	50
26713D-24-24W	1-7/8x12	40	24	50.2	19.5	50	55
26713D-32-32W	2-1/2x12	50	32	52	24	65	75

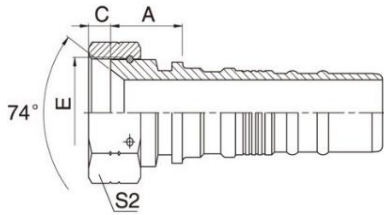
F JIS GAS - 60° Cone Seal
日本英制内螺纹60°内锥面

29613-W

PART NO 型号	THREAD	HOSE		DIMENSION			
	螺纹	软管		尺寸			
	E	DN	DASH	A	C	S1	S2
29613-12-12W	G3/4x14	20	12	40	14	32	32
29613-16-16W	G1x11	25	16	44	16	41	41
29613-20-20W	G1-1/4x11	32	20	49	19	50	50
29613-24-24W	G1-1/2x11	40	24	49	19	55	55
29613-32-32W	G2x11	50	32	52	23	70	70

CODE 62 FLANGE SERIES SAE 法兰6000 PSI系列

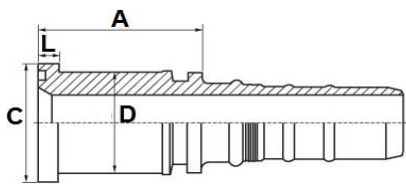
Code 62 Flange - 6000 PSI
SAE 法兰6000 PSI

87613

PART NO 型号	SIZE 尺寸	HOSE		DIMENSION			
		软管		尺寸			
		DN	DASH	A	C	D	L
87613-12-12	3/4"	20	12	53	41	32	9
87613-16-12	1"	20	12	58	48	38	10
87613-16-16	1"	25	16	59	48	38	10
87613-20-16	1-1/4"	25	16	67	54	44	10
87613-20-20	1-1/4"	32	20	70	54	44	10
87613-20-24	1-1/4"	40	24	75	54	44	10
87613-24-20	1-1/2"	32	20	79	64	51	13
87613-24-24	1-1/2"	40	24	79	64	51	13
87613-32-24	2"	40	24	91	79	67	13
87613-32-32	2"	50	32	91	79	67	13

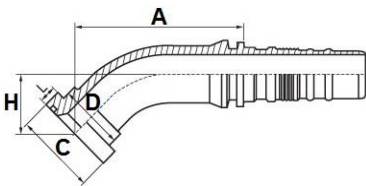
Code 62 Flange - 6000 PSI - 45°
45°SAE 法兰6000 PSI

87643

PART NO 型号	SIZE 尺寸	HOSE		DIMENSION				
		软管		尺寸				
		DN	DASH	A	C	D	H	L
87643-12-12	3/4"	20	12	89	41	32	32	9
87643-16-12	1"	20	12	91	48	38	34	10
87643-16-16	1"	25	16	101	48	38	35	10
87643-20-16	1-1/4"	25	16	104	54	44	38	10
87643-20-20	1-1/4"	32	20	117	54	44	42	10
87643-24-20	1-1/2"	32	20	120	64	51	45	13
87643-24-24	1-1/2"	40	24	135	64	51	49	13
87643-32-24	2"	40	24	140	79	67	55	13
87643-32-32	2"	50	32	163	79	67	62	13

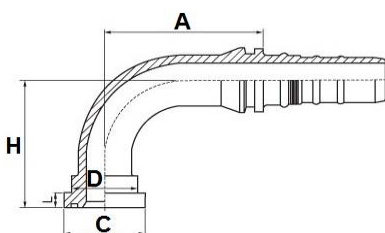
Code 62 Flange - 6000 PSI - 90°
90°SAE 法兰6000 PSI

87693

PART NO 型号	SIZE 尺寸	HOSE		DIMENSION				
		软管		尺寸				
		DN	DASH	A	C	D	H	L
87693-12-12	3/4"	20	12	75	41	32	66	9
87693-16-12	1"	20	12	75	48	38	69	10
87693-16-16	1"	25	16	89	48	38	75	10
87693-20-16	1-1/4"	25	16	89	54	44	79	10
87693-20-20	1-1/4"	32	20	106	54	44	90	10
87693-24-20	1-1/2"	32	20	106	64	51	95	13
87693-24-24	1-1/2"	40	24	124	64	51	108	13
87693-32-24	2"	40	24	124	79	67	116	13
87693-32-32	2"	50	32	150	79	67	136	13

Flange - 9000 PSI
SAE 法兰9000 PSI

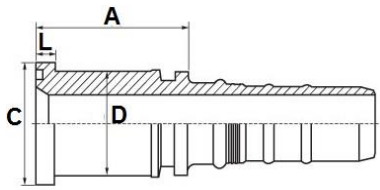

87913

PART NO 型号	SIZE 尺寸	HOSE 软管		DIMENSION 尺寸			
		DN	DASH	A	C	D	L
		87913-12-12	3/4"	20	12	59	41
87913-16-12	1"	20	12	63	48	38	14
87913-16-16	1"	25	16	64	48	38	14
87913-20-16	1-1/4"	25	16	71	54	43	14
87913-20-20	1-1/4"	32	20	74	54	43	14
87913-24-20	1-1/2"	32	20	81	64	51	14
87913-24-24	1-1/2"	40	24	81	64	51	14

Flange - 9000 PSI - 45°
45°SAE 法兰9000 PSI

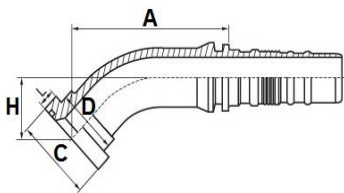

87943

PART NO 型号	SIZE 尺寸	HOSE 软管		DIMENSION 尺寸				
		DN	DASH	A	C	D	H	L
		87943-12-12	3/4"	20	12	93	41	32
87943-16-12	1"	20	12	94	48	38	37	14
87943-16-16	1"	25	16	104	48	38	38	14
87943-20-16	1-1/4"	25	16	105	54	43	38	14
87943-20-20	1-1/4"	32	20	117	54	43	42	14
87943-24-20	1-1/2"	32	20	118	64	51	43	14
87943-24-24	1-1/2"	40	24	133	64	51	47	14

Flange - 9000 PSI - 90°
90°SAE 法兰9000 PSI

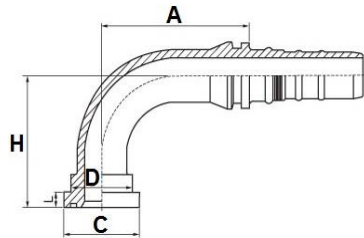

87993

PART NO 型号	SIZE 尺寸	HOSE 软管		DIMENSION 尺寸				
		DN	DASH	A	C	D	H	L
		87993-12-12	3/4"	20	12	75	41	32
87993-16-12	1"	20	12	75	48	38	73	14
87993-16-16	1"	25	16	89	48	38	79	14
87993-20-16	1-1/4"	25	16	89	54	43	80	14
87993-20-20	1-1/4"	32	20	106	54	43	91	14
87993-24-20	1-1/2"	32	20	106	64	51	92	14
87993-24-24	1-1/2"	40	24	124	64	51	105	14

DOUBLE CONNECTOR 双面连接芯

Double Connector
双面连接芯

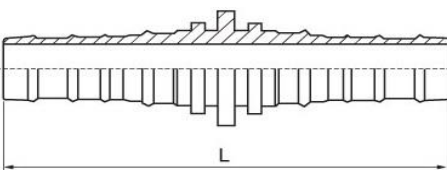

90013

PART NO 型号	HOSE 软管		DIMENSION 尺寸
	DN	DASH	L
	90013-12	20	12
90013-16	25	16	150
90013-20	32	20	194
90013-24	40	24	223
90013-32	50	32	235

Reusable Ferrule for R5 SAE 100 R5软管可拆式套筒

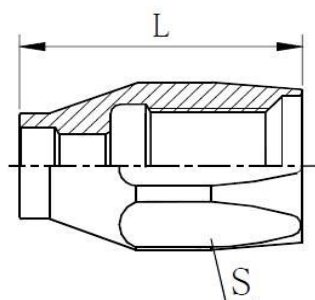

00518

PART NO 型号	HOSE 软管		DIM. 尺寸	
	DN	DASH	L	S
	00518-04	5	4	28
00518-05	6	5	31	19
00518-06	8	6	33	22
00518-08	11	8	42	24
00518-10	13	10	46	30
00518-12	16	12	54	32
00518-16	22	16	42	36
00518-20	28	20	45	46
00518-24	35	24	47	50
00518-32	50	32	57	65

F Metric L - 24° Cone with O-Ring 公制内螺纹24°内锥面轻系列

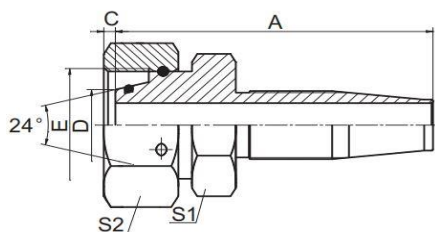

20418D

PART NO 型号	THREAD 螺纹	HOSE 软管		TUBE 硬管	DIMENSION 尺寸			
	E	DN	DASH	OD	A	C	S1	S2
	20418D-14-04	M14x1.5	5	4	8	31	1.1	12
20418D-16-05	M16x1.5	6.3	5	10	33	1.3	14	19
20418D-18-06	M18x1.5	8	6	12	33	1.5	17	22
20418D-22-08	M22x1.5	11	8	15	36	2	19	27
20418D-26-10	M26x1.5	12.5	10	18	42	2.4	27	32
20418D-30-12	M30x2	16	12	22	44	2.4	30	36
20418D-36-16	M36x2	22	16	28	42	3	36	41
20418D-45-16	M45x2	22	16	35	45	3.1	41	50
20418D-45-20	M45x2	29	20	35	45	3.1	41	50
20418D-52-24	M52x2	35	24	42	49	3.6	50	60

F Metric S - 24° Cone with O-Ring 45°公制内螺纹24°内锥面轻系列

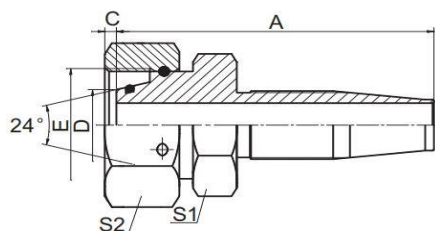

20518D

PART NO 型号	THREAD 螺纹	HOSE 软管		TUBE 硬管	DIMENSION 尺寸			
	E	DN	DASH	OD	A	C	H	S2
	20518D-16-04	M14x1.5	5	4	8	32	2	14
20518D-16-05	M16x1.5	6.3	5	8	33	2	14	19
20518D-18-04	M18x1.5	5	4	10	32	2	17	22
20518D-18-06	M18x1.5	8	6	10	33	2	17	22
20518D-20-06	M20x1.5	8	6	12	34	2	17	24
20518D-22-06	M22x1.5	8	6	14	33	2	19	27
20518D-24-08	M24x1.5	11	8	16	37	2	22	30
20518D-30-10	M30x2	12.5	10	20	45	3	27	36
20518D-30-12	M30x2	16	12	20	46	3	27	36
20518D-36-12	M36x2	16	12	25	47	5	36	41
20518D-36-16	M36x2	22	16	25	43	5	36	41
20518D-42-16	M42x2	22	16	30	46	6	41	50
20518D-42-20	M42x2	29	20	30	46	6	41	50
20518D-52-20	M52x2	29	20	38	48	7	50	60
20518D-52-24	M52x2	35	24	38	48	7	50	60

F BSP - 60° Cone
英管内螺纹60°外锥面

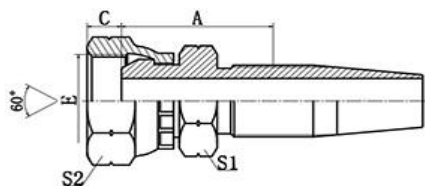

22618D

PART NO 型号	THREAD	HOSE		DIMENSION			
	螺纹	软管		尺寸			
	E	DN	DASH	A	C	S1	S2
22618D-04-04	G1/4"X19	5	4	26	6	14	19
22618D-06-05	G3/8"X19	6	5	29.1	6	17	22
22618D-06-06	G3/8"X19	8	6	30	6	17	22
22618D-08-08	G1/2"X14	11	8	35	8	19	27
22618D-10-10	G5/8"X14	13	10	35.5	10	22	30
22618D-12-12	G3/4"X14	16	12	38.5	11	27	32
22618D-16-16	G1"X11	22	16	37	12	32	41
22618D-20-20W	G1.1/4"X11	28	20	41.5	11	41	50

MALE NPT THREAD 60° CONE SEAL SERIES 美制锥管外螺纹系列

M NPT
美制锥管外螺纹

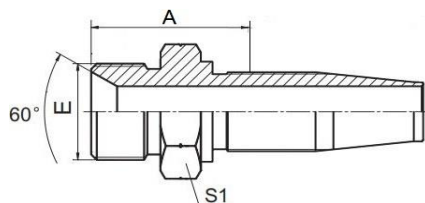

15618

PART NO 型号	THREAD	HOSE		DIM.	
	螺纹	软管		尺寸	
	E	DN	DASH	A	S1
15618-02-04	1/8x27	5	4	25.5	12
15618-04-04	1/4x18	5	4	30	17
15618-04-06	1/4x18	8	6	31	17
15618-06-05	3/8x18	6	5	32.9	19
15618-06-06	3/8x18	8	6	32	19
15618-08-08	1/2x14	11	8	40.5	22
15618-12-10	3/4x14	13	10	42.5	30
15618-12-12	3/4x14	16	12	43	30
15618-16-16	1x11.5	22	16	46.5	36
15618-20-20	1-1/4x11.5	28	20	51.5	46
15618-24-24	1-1/2x11.5	35	24	52.5	50
15618-32-32	2x11.5	50	32	55	65

MALE JIC THREAD 74° CONE SEAL 美制JIC外螺纹74°外锥面

M JIC - 74° Cone Seal
美制JIC外螺纹74°外锥面

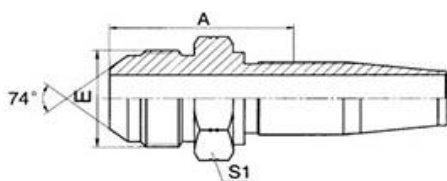

16718

PART NO 型号	THREAD	HOSE		DIM.	
	螺纹	软管		尺寸	
	E	DN	DASH	A	S1
16718-04-04	7/16"X20	5	4	29	12
16718-06-05	9/16"X18	6	5	31	17
16718-06-06	9/16"X18	8	6	32	17
16718-08-06	3/4"X16	8	6	34.7	22
16718-08-08	3/4"X16	11	8	38	22
16718-10-10	7/8"X14	13	10	40.5	24
16718-12-12	1.1/16"X12	16	12	45.5	30
16718-16-16	1.5/16"X12	22	16	44	36
16718-20-20	1.5/8"X12	28	20	49.5	46
16718-24-24	1.7/8"X12	35	24	52.5	50

F JIC - 74° Cone Seal
美制JIC内螺纹74° 内锥面

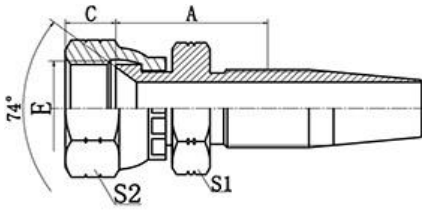

26718D

PART NO 型号	THREAD	HOSE		DIMENSION			
	螺纹	软管		尺寸			
	E	DN	DASH	A	C	S1	S2
26718D-04-04	7/16"X20	5	4	22	9	14	17
26718D-05-05	1/2"X20	6	5	25.4	10	14	17
26718D-06-06	9/16"X18	8	6	24.5	11	17	19
26718D-08-08	3/4"X16	11	8	31.5	11	22	24
26718D-10-10	7/8"X14	13	10	34	13	27	27
26718D-12-12	1.1/16"X12	16	12	37	15	32	32
26718D-16-16	1.5/16"X12	22	16	33.5	16	38	41
26718D-20-20W	1.5/8"X12	28	20	41.5	17	41	50
26718D-24-24W	1.7/8"X12	35	24	43	20	46	55
26718D-32-32W	2.1/2"X12	52	32	46	24	65	75

F JIC - 74° Cone Seal
美制JIC内螺纹74° 内锥面

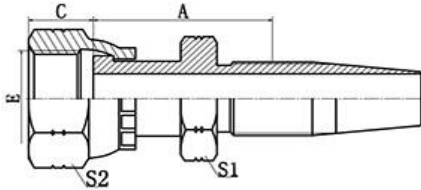

24218D

PART NO 型号	THREAD	HOSE		DIMENSION			
	螺纹	软管		尺寸			
	E	DN	DASH	A	C	S1	S2
24218D-04-04	9/16x18	5	4	30.5	8	14	17
24218D-04-05	9/16x18	6.3	5	32	8	14	17
24218D-06-06	11/16x16	8	6	34.5	10	17	22
24218D-08-08	13/16x16	11	8	41.5	11	19	24
24218D-10-10	1x14	12.5	10	47.5	14	24	30
24218D-12-12	1-3/16x12	16	12	50.5	15	30	36
24218D-16-16	1-7/16x12	22	16	49	15	36	41
24218D-20-20W	1-11/16x12	29	20	54.5	15	41	50
24218D-24-24W	2x12	35	24	57	15	50	60

Code 61 Flange - 3000 PSI
SAE 法兰 3000 PSI

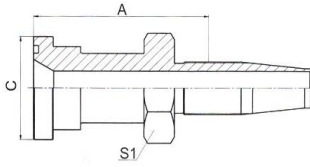

87318D

PART NO 型号	SIZE 尺寸	HOSE 软管		DIMENSION 尺寸		
		DN	DASH	A	C	S1
		87318D-08-08	1/2"	11	8	54
87318D-12-12	3/4"	16	12	55	38	27
87318D-16-16	1"	22	16	55	44	32
87318D-20-20	1-1/4"	29	20	58	51	41
87318D-24-24	1-1/2"	35	24	70	60	46
87318D-32-32	2"	46	32	72	71	60

Code 61 Flange - 3000 PSI - 90°
90° SAE 法兰 3000 PSI

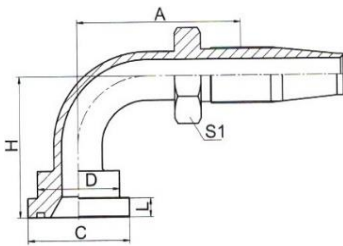

87398D

PART NO 型号	SIZE 尺寸	HOSE 软管		DIMENSION 尺寸					
		DN	DASH	A	C	D	H	L	S1
		87398D-08-08	1/2"	11	8	53	30	24	47
87398D-12-10	3/4"	12.5	10	67	38	32	53	7	32
87398D-12-12	3/4"	16	12	80	38	32	62	7	32
87398D-16-12	1"	16	12	80	44	38	62	8	32
87398D-16-16	1"	22	16	87	44	38	68	8	41
87398D-20-16	1-1/4"	22	16	87	51	43	68	8	41
87398D-20-20	1-1/4"	29	20	101	51	43	79	8	50
87398D-24-20	1-1/2"	29	20	101	60	50	81	8	50
87398D-24-24	1-1/2"	35	24	108	60	50	94	8	55
87398D-32-24	2"	35	24	108	71	62	94	10	55
87398D-32-32	2"	46	32	129	71	62	114	10	70

Code 62 Flange - 6000 PSI - 90°
90° SAE 法兰 6000 PSI

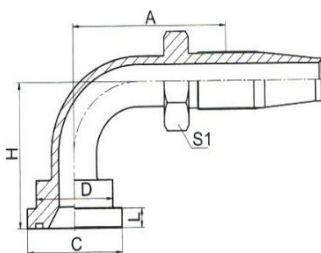

87698D

PART NO 型号	SIZE 尺寸	HOSE 软管		DIMENSION 尺寸					
		DN	DASH	A	C	D	H	L	S1
		87698D-08-08	1/2"	11	8	53	32	24	48
87698D-12-10	3/4"	12.5	10	67	41	32	57	9	32
87698D-12-12	3/4"	16	12	80	41	32	66	9	32
87698D-16-12	1"	16	12	80	48	38	69	10	32
87698D-16-16	1"	22	16	87	48	38	75	10	41
87698D-20-16	1-1/4"	22	16	87	54	44	79	10	41
87698D-20-20	1-1/4"	29	20	101	54	44	90	10	50
87698D-24-20	1-1/2"	29	20	101	64	51	95	13	50
87698D-24-24	1-1/2"	35	24	108	64	51	108	13	55
87698D-32-24	2"	35	24	108	79	67	116	13	55
87698D-32-32	2"	46	32	129	79	67	136	13	70